

33 800 682



- sporgenza 201 mm
- bocca girevole 360°
- Possibilità di limitarne la rotazione con il set di riduzione 12 820 970 90
- Getto con aria
- portata max 6,3 l/min a una pressione idraulica di 3 bar
- senza piombo
- Questo prodotto può aiutare un edificio a soddisfare i requisiti dei Green Building Rating Systems, ad es. LEED®, BREEAM®, DGNB

	Champagne spazzolato (Oro 22k)	33 800 682-46
	Cromato	33 800 682-00
	Platinato spazzolato	33 800 682-06
	Platinato	33 800 682-08
	Ottone (Oro 23k)	33 800 682-09
	Dark Chrome	33 800 682-19
	Ottone spazzolato (Oro 23k)	33 800 682-28
	Nero opaco	33 800 682-33
	Champagne (Oro 22k)	33 800 682-47
	Cromo spazzolato	33 800 682-93
	Dark Platinum spazzolato	33 800 682-99

Prodotti complementari

	Set limitazione di giro -	12 820 970 90
---	----------------------------------	---------------

Prodotti complementari

	Dispenser senza rosetta - Champagne spazzolato (Oro 22k)	82 424 970-46
---	---	---------------

Prodotti complementari

	Comando piletta ad eccentrico con manopola con manopola - Champagne spazzolato (Oro 22k)	10 712 970-46
---	---	---------------

33 800 682



Diagramma di portata



Certificati

LGA_38646.

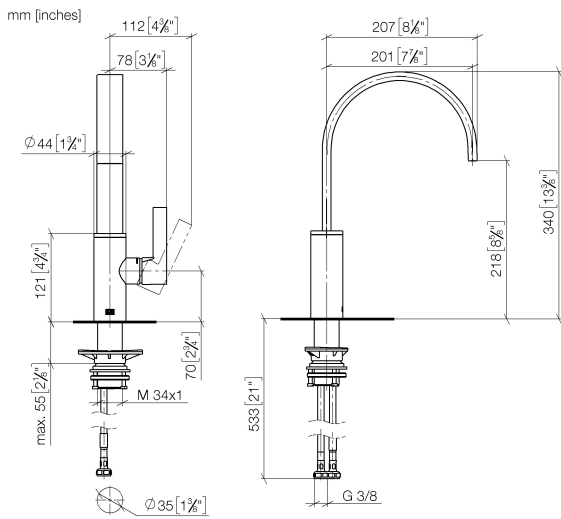
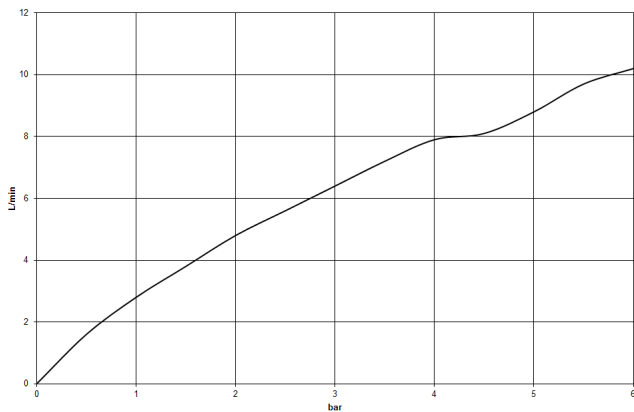
WRAS_240202021.

33 800 682

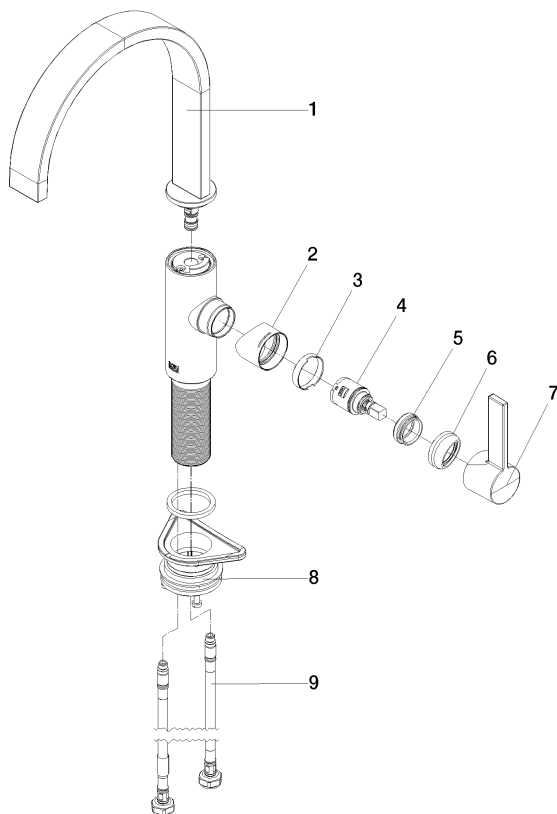

Elenco delle parti di ricambio

N.	Codice articolo	Denominazione	Quantità necessaria	Tempo di produzione
1	90 28 22 332 00-46	bocca di erogazione	1	-
Il pezzo di ricambio non può più essere ordinato, si prega di ordinare l'articolo sostitutivo				
2	09 19 86 012-46	copertura	1	60
3	90 23 10 128 00 90	dado	1	2
4	90 15 05 042 00 90	cartuccia	1	2
5	09 24 04 266 90	dado	1	2
6	90 28 30 052 00-46	copertura	1	30
7	90 20 86 004 00-46	manopola	1	30
8	04 23 10 044 08 90	set di fissaggio	1	2
9	04 30 04 101 00 90	flessibile	2	2