







36 860 845



- sporgenza 170 mm
- bocca fissa
- Getto circolare con aria
- diametro foro rubinetteria 37 mm
- diametro foro miscelatore monocomando 57 mm
- rosetta 78 x 78 mm
- portata max 5,7 l/min
- senza piombo
- Questo prodotto può aiutare un edificio a soddisfare i requisiti dei Green Building Rating Systems, ad es. LEED®, BREEAM®, DGNB

	Nero opaco	36 860 845-33
	Cromato	36 860 845-00
	Platinato spazzolato	36 860 845-06
	Dark Chrome	36 860 845-19
	Cromo spazzolato	36 860 845-93
	Dark Platinum spazzolato	36 860 845-99

Prodotti complementari necessari



Miscelatore monocomando da incasso miscelatore a destra - 35 816 970 90
 ●ATTENZIONE:Non idoneo per montaggio a incasso.Raccordo tramite rubinetti di chiusura a squadra, fissaggio tramite avvitamento alla parete posteriore.

Prodotti complementari necessari



Miscelatore monocomando da incasso - 35 860 970 90
 ●Profondità d'incasso max. 95 mm
 ●profondità d'incasso min. 75 mm

36 860 845

mm [inches]



Diagramma di portata



Certificati

IAPMO_N-4976 (2). DVGW_DW-6512DN0435. IAPMO_8834 (2). IAPMO_6397 (2). WRAS_2107018.

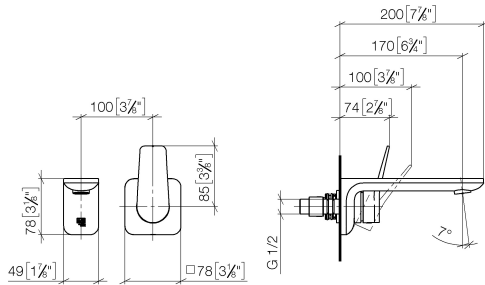
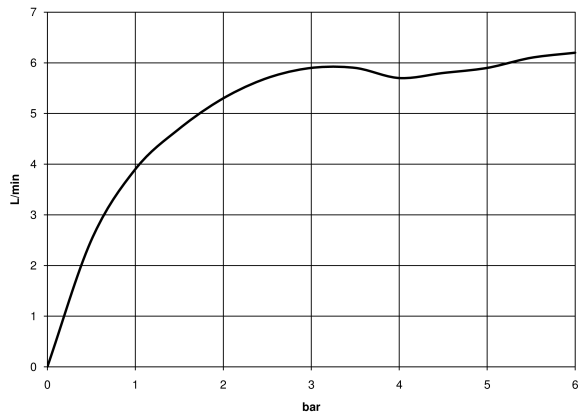
36 860 845

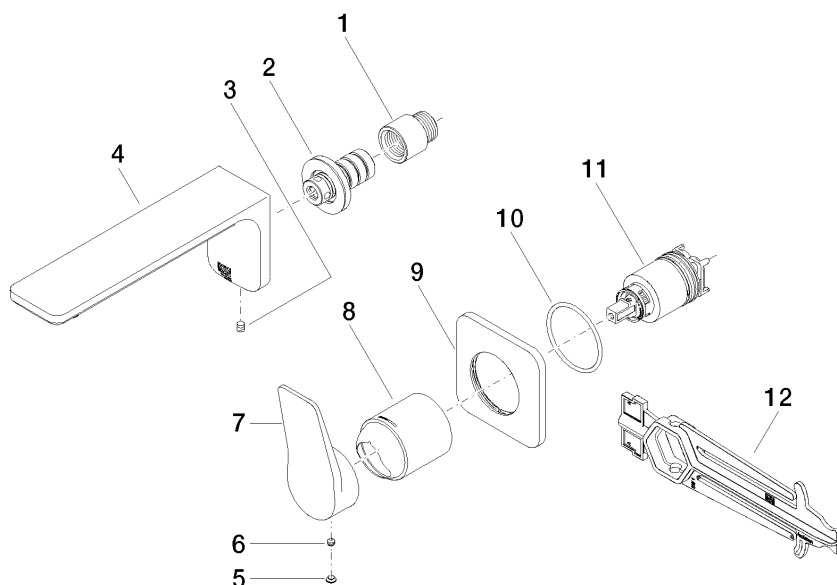

Elenco delle parti di ricambio

N.	Codice articolo	Denominazione	Quantità necessaria	Tempo di produzione
1	09 24 03 072 10 90	ugello	1	2
2	90 24 03 108 00 90	set di nippel	1	2
3	90 31 11 004 00 90	perno	1	2
4	90 11 84 021 00-33	bocca di erogazione	1	30
5	90 31 20 087 00-33	tappo	1	30
6	90 31 11 063 00 90	perno	1	2
7	09 20 84 021-33	manopola	1	30
8	09 11 02 288-33	copertura	1	30
9	90 27 84 020 00-33	rosetta	1	30
10	90 14 10 049 00 90	guarnizione	1	2
11	90 15 05 064 01 90	cartuccia	1	2
12	90 30 09 064 00 90	chiave	1	2