







83 060 361



- interasse 600 mm
- larghezza 660mm
- altezza 60 mm
- rosetta Ø 60 mm
- sporgenza 90 mm

	Ottone (Oro 23k)	83 060 361-09
	Cromato	83 060 361-00
	Platinato spazzolato	83 060 361-06
	Platinato	83 060 361-08
	Ottone spazzolato (Oro 23k)	83 060 361-28
	Dark Platinum spazzolato	83 060 361-99

Prodotti complementari



MADISON Fissaggio per deviatore per montaggio su vetro bifacciale 12 358 970 90

-
- Per il fissaggio di un'asta portasciugamani più un'asta portasciugamani sul retro.

83 060 361

mm [inches]

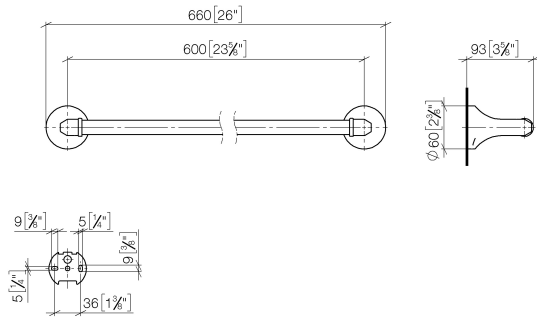

83 060 361

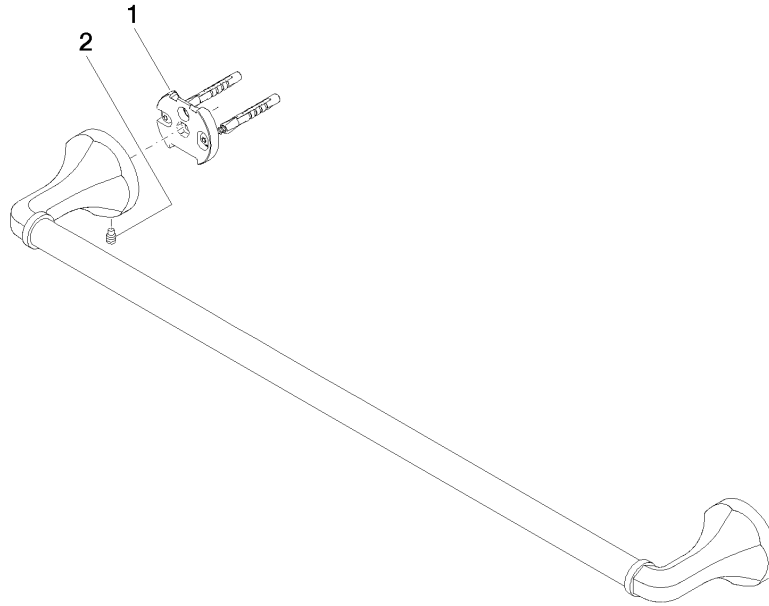

Elenco delle parti di ricambio

N.	Codice articolo	Denominazione	Quantità necessaria	Tempo di produzione
1	05 17 97 507 00 90	set di fissaggio	2	2
2	04 31 11 140 00 90	perno	2	2