

83 060 892



- interasse 600 mm
- larghezza 655mm
- altezza 55 mm
- rosetta Ø 55 mm
- sporgenza 81 mm

Compatibile con TARA

	Platinato	83 060 892-08
	Cromato	83 060 892-00
	Platinato spazzolato	83 060 892-06
	Dark Chrome	83 060 892-19
	Ottone spazzolato (Oro 23k)	83 060 892-28
	Nero opaco	83 060 892-33
	Champagne spazzolato (Oro 22k)	83 060 892-46
	Champagne (Oro 22k)	83 060 892-47
	Cromo spazzolato	83 060 892-93
	Dark Platinum spazzolato	83 060 892-99

83 060 892

mm [inches]



83 060 892

Parts for other  
finishes can be found  
here: Cromato

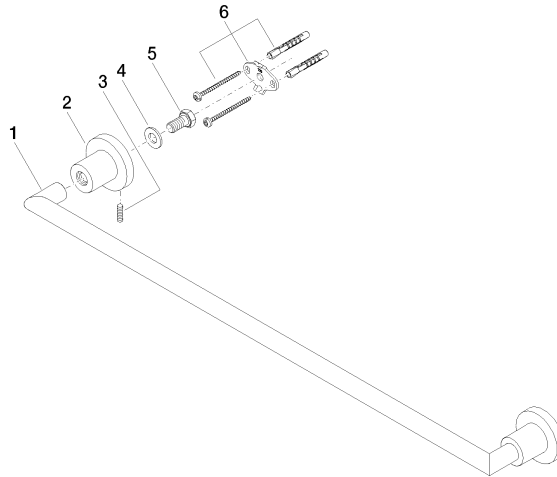

## Elenco delle parti di ricambio

N.	Codice articolo	Denominazione	Quantità necessaria	Tempo di produzione
1	05 28 22 589 00-08	sostegno	1	40
2	08 17 89 505-08	sostegno	2	40
3	04 31 11 113 00 90	perno	2	2
4	09 30 11 046 90	rondella	2	2
5	09 30 30 071 90	vite	2	2
6	05 17 20 739 00 90	set di fissaggio	2	2