

ST 050 203 1892



- asta da parete con supporto scorrevole
- Diametro del tubo 18 mm
- rosette Ø 55 mm
- interasse 800 mm
- Flessibile doccetta in metallo 1750mm con protezione antitorsione integrata
- Attacco tubo doccia 3/8"
- A tre o regolazioni: COMPACT RAIN, COMPACT SOFT FLOW, COMPACT AQUAPRESSURE FLOW, portata max. 15 l/min (a 3 bar)
- Funzione a partire da: 7 l/min
- Soffione Ø 100mm

	Ottone spazzolato (Oro 23k)	ST 050 203 1892-28
	Cromato	ST 050 203 1892-00
	Platinato spazzolato	ST 050 203 1892-06
	Platinato	ST 050 203 1892-08
	Dark Chrome	ST 050 203 1892-19
	Nero opaco	ST 050 203 1892-33
	Champagne spazzolato (Oro 22k)	ST 050 203 1892-46
	Champagne (Oro 22k)	ST 050 203 1892-47
	Cromo spazzolato	ST 050 203 1892-93
	Dark Platinum spazzolato	ST 050 203 1892-99

Componenti singoli di questo set

Per questo set sono necessari i seguenti componenti



1x 26 413 892-28



1x 28 018 979-28

ST 050 203 1892



- asta da parete con supporto scorrevole
- Diametro del tubo 18 mm
- rosette Ø 55 mm
- interasse 800 mm
- Flessibile doccetta in metallo 1750mm con protezione antitorsione integrata
- Attacco tubo doccia 3/8"

Questo articolo non include la doccetta!

	Ottone spazzolato (Oro 23k)	26 413 892-28
	Cromato	26 413 892-00
	Platinato spazzolato	26 413 892-06
	Platinato	26 413 892-08
	Dark Chrome	26 413 892-19
	Nero opaco	26 413 892-33
	Champagne spazzolato (Oro 22k)	26 413 892-46
	Champagne (Oro 22k)	26 413 892-47
	Cromo spazzolato	26 413 892-93
	Dark Platinum spazzolato	26 413 892-99

Prodotti complementari

	raccordo angolare ad incasso - ●Profondità d'incasso max. 163 mm ●profondità d'incasso min. 90 mm	35 085 970 90
--	--	---------------

Prodotti complementari

	Raccordo curvo - Ottone spazzolato (Oro 23k)	28 450 625-28
--	---	---------------

Prodotti complementari necessari

	Doccetta - Ottone spazzolato (Oro 23k)	28 016 979-28
--	---	---------------

Prodotti complementari necessari

	Doccetta - Ottone spazzolato (Oro 23k)	28 018 979-28
--	---	---------------

Prodotti complementari necessari

	Doccetta - Ottone spazzolato (Oro 23k)	28 017 979-28
--	---	---------------

Prodotti complementari necessari

	Doccetta - Ottone spazzolato (Oro 23k)	28 012 979-28
--	---	---------------

Prodotti complementari necessari

	Doccetta FlowReduce - Ottone spazzolato (Oro 23k)	28 012 979-28 0010
--	--	--------------------

Prodotti complementari necessari

	Doccetta FlowReduce - Ottone spazzolato (Oro 23k)	28 016 979-28 0010
--	--	--------------------

Prodotti complementari necessari

	Doccetta FlowReduce - Ottone spazzolato (Oro 23k)	28 018 979-28 0010
--	--	--------------------

ST 050 203 1892
mm [inches]

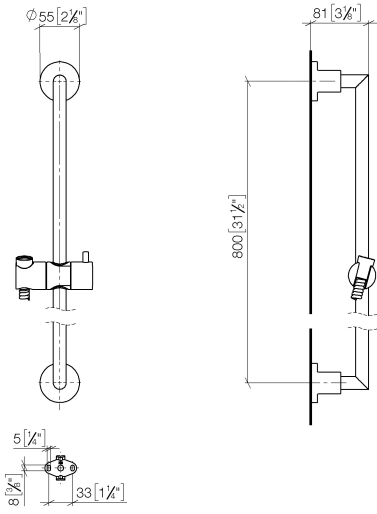

Certificati

WRAS_2009048.

ACS_20 ACC LY 738.

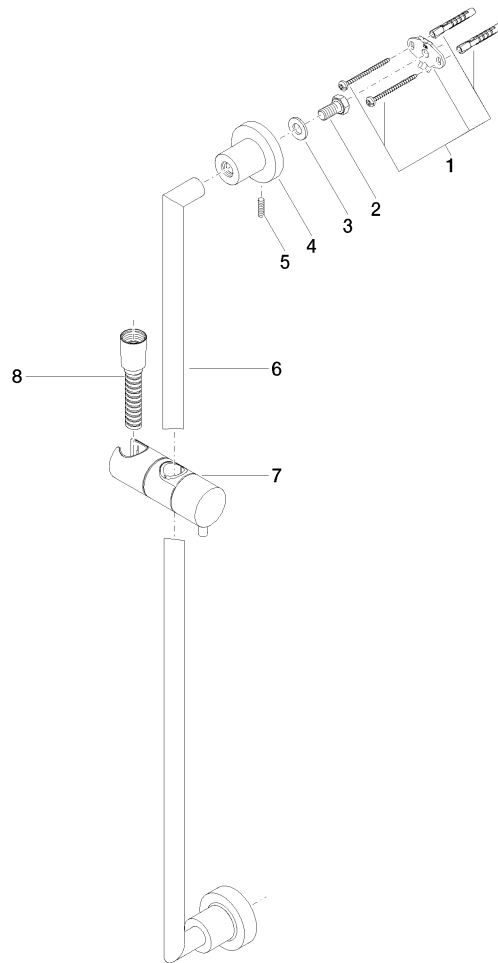

Elenco delle parti di ricambio

N.	Codice articolo	Denominazione	Quantità necessaria	Tempo di produzione
1	05 17 20 739 00 90	set di fissaggio	2	2
2	09 30 30 071 90	vite	2	2
3	09 30 11 046 90	rondella	2	2
4	08 17 89 505-28	sostegno	2	20
5	04 31 11 113 00 90	perno	2	2
6	05 28 22 590 00-28	barra	1	20
7	12 580 970-28	Supporto scorrevole - Ottone spazzolato (Oro 23k)	1	20
8	28 322 970-28	Flessibile metallico per doccia 1/2" x 3/8" x 1750 mm - Ottone spazzolato (Oro 23k)	1	20

TARA Gruppo doccetta con flessibile e asta saliscendi - Ottone spazzolato (Oro 23k)

TARA





























ST 050 203 1892



- A tre o regolazioni: COMPACT RAIN, COMPACT SOFT FLOW, COMPACT AQUAPRESSURE FLOW, portata max. 15 l/min (a 3 bar)
- con sistema anticalcare
- Soffione Ø 100mm
- ingresso 1/2"
- Funzione a partire da: 7 l/min

Sistema di sicurezza antiriflusso.

Compatibile con: IMO, LULU, MADISON, MEM, TARA, CL.1, LISSÉ, VAIA, META, CYO

	Ottone spazzolato (Oro 23k)	28 018 979-28
	Cromato	28 018 979-00
	Cromato	28 018 979-00 0010
	Platinato spazzolato	28 018 979-06
	Platinato spazzolato	28 018 979-06 0010
	Platinato	28 018 979-08
	Platinato	28 018 979-08 0010
	Dark Brass matt	28 018 979-16 0010
	Dark Bronze matt	28 018 979-17 0010
	Dark Chrome	28 018 979-19
	Dark Chrome	28 018 979-19 0010
	Light Gold	28 018 979-26 0010
	Light Gold	28 018 979-26
	Light Gold spazzolato	28 018 979-27 0010
	Light Gold spazzolato	28 018 979-27
	Ottone spazzolato (Oro 23k)	28 018 979-28 0010
	Nero opaco	28 018 979-33
	Nero opaco	28 018 979-33 0010
	Bronzo spazzolato	28 018 979-42
	Bronzo spazzolato	28 018 979-42 0010
	Champagne spazzolato (Oro 22k)	28 018 979-46
	Champagne spazzolato (Oro 22k)	28 018 979-46 0010
	Champagne (Oro 22k)	28 018 979-47
	Champagne (Oro 22k)	28 018 979-47 0010
	Cromo spazzolato	28 018 979-93
	Cromo spazzolato	28 018 979-93 0010
	Dark Platinum spazzolato	28 018 979-99
	Dark Platinum spazzolato	28 018 979-99 0010

ST 050 203 1802
mm [inches]



Diagramma di portata



Certificati

LGA_29984.

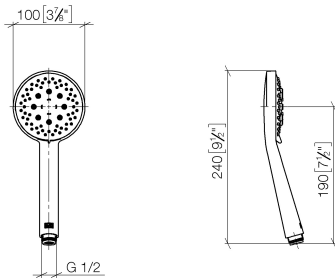
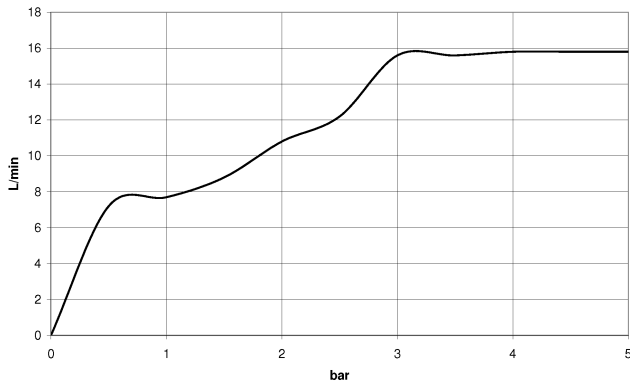
DVGW_DW-
6517DN0129.

WRAS_2210003.

ST 050 203 1892
Parts for other
finishes can be found
here: Cromato

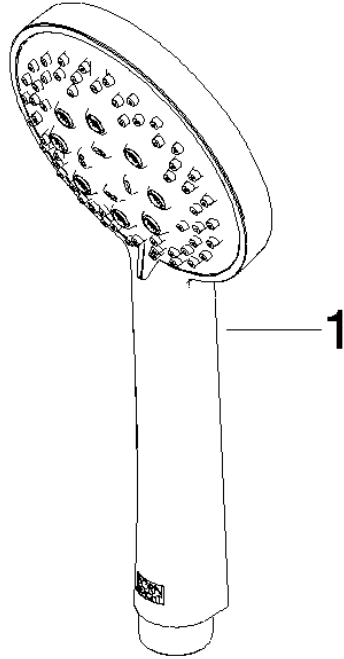

Elenco delle parti di ricambio

N.	Codice articolo	Denominazione	Quantità necessaria	Tempo di produzione
1	09 23 01 039 90	setaccio	1	2