

ST 050 608 3979



Compatibile con: IMO, MEM, CL.1, CYO

- LAMINAR FLOW, portata max. 15 l/min (a 3 bar)
- con regolatore di portata
- rosetta separata 60 x 60 mm
- supporto per tubo flessibile Kneipp
- raccordo curvo 1/2"
- boccola del tubo flessibile con manicotto M33
- con anello di fissaggio

	Champagne spazzolato (Oro 22k)	ST 050 608 3979-46
	Cromato	ST 050 608 3979-00
	Platinato spazzolato	ST 050 608 3979-06
	Platinato	ST 050 608 3979-08
	Dark Chrome	ST 050 608 3979-19
	Light Gold spazzolato	ST 050 608 3979-27
	Ottone spazzolato (Oro 23k)	ST 050 608 3979-28
	Nero opaco	ST 050 608 3979-33
	Champagne (Oro 22k)	ST 050 608 3979-47
	Cromo spazzolato	ST 050 608 3979-93
	Dark Platinum spazzolato	ST 050 608 3979-99

Componenti singoli di questo set

Per questo set sono necessari i seguenti componenti

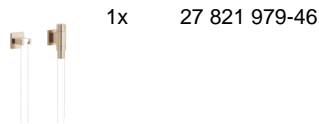

1x 27 821 979-46

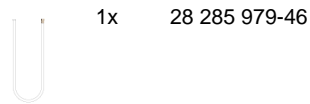

1x 28 285 979-46

ST 050 608 3979



Compatibile con: IMO, MEM, CL.1, CYO

- LAMINAR FLOW, portata max. 15 l/min (a 3 bar)
- con regolatore di portata
- rosetta 60 x 60 mm
- supporto per tubo flessibile Kneipp
- raccordo curvo 1/2"
- senza tubo flessibile

Sistema di sicurezza antiriflusso.

Modifica del prodotto a partire dall'1.4.2023: portata max 15 l/min

	Champagne spazzolato (Oro 22k)	27 821 979-46
	Cromato	27 821 979-00
	Platinato spazzolato	27 821 979-06
	Platinato	27 821 979-08
	Dark Chrome	27 821 979-19
	Light Gold spazzolato	27 821 979-27
	Ottone spazzolato (Oro 23k)	27 821 979-28
	Nero opaco	27 821 979-33
	Champagne (Oro 22k)	27 821 979-47
	Cromo spazzolato	27 821 979-93
	Dark Platinum spazzolato	27 821 979-99

Prodotti complementari

- | | |
|--|---|
| | raccordo angolare ad incasso - 35 085 970 90 |
| | ●Profondità d'incasso max. 163 mm |
| | ●profondità d'incasso min. 90 mm |

Prodotti complementari necessari

- | | |
|--|---|
| | WATER TUBE WATER TUBE tubo flessibile Kneipp bianco 2000 mm - Champagne spazzolato (Oro 22k) 28 285 979-46 |
| | ●con anello di fissaggio |
| | ●boccola del tubo flessibile con manicotto M33 |

Prodotti complementari necessari

- | | |
|--|---|
| | WATER TUBE WATER TUBE tubo flessibile Kneipp nero 2000 mm - Champagne spazzolato (Oro 22k) 28 286 979-46 |
| | ●con anello di fissaggio |
| | ●boccola del tubo flessibile con manicotto M33 |

ST 050 608 3979

mm [inches]



Diagramma di portata



Certificati

Belgaqua_22_280_2
7_7.

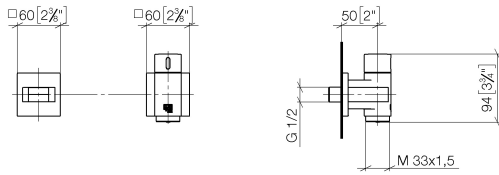
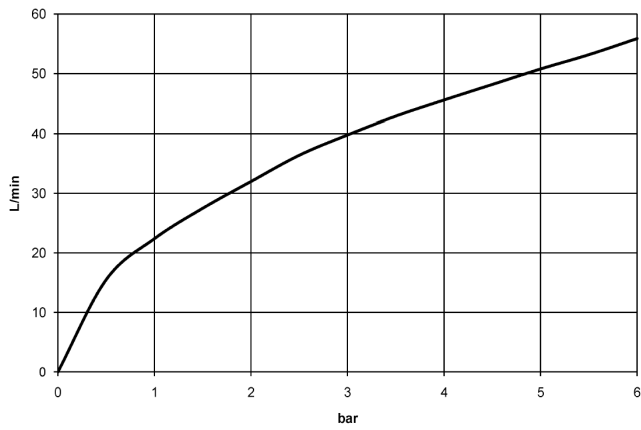
ST 050 608 3979

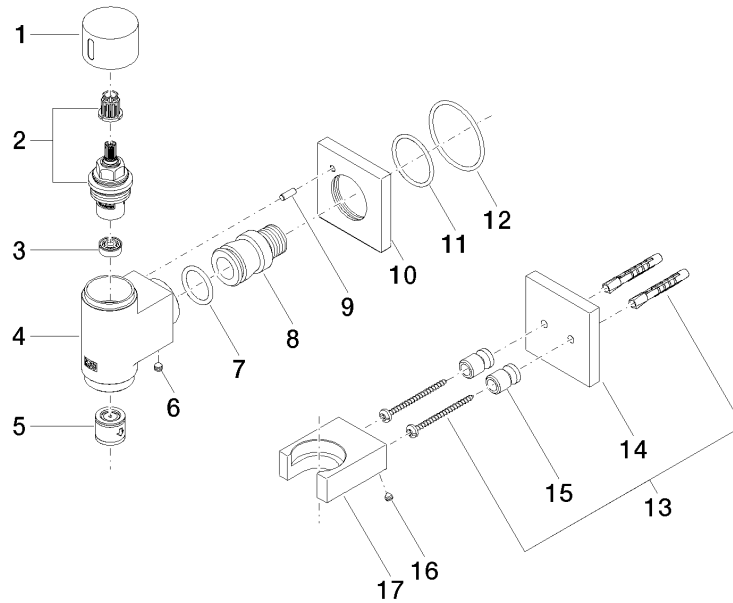

Elenco delle parti di ricambio

N.	Codice articolo	Denominazione	Quantità necessaria	Tempo di produzione
1	09 20 97 021-46	manopola	1	60
2	90 90 03 145 00 90	parte superiore	1	2
3	90 23 01 146 00 90	limitatore di portata	1	2
4	09 11 03 135-46	attacco	1	60
5	90 23 01 045 00 90	valvola di non ritorno	1	2
6	90 31 11 112 00 90	perno	1	2
7	09 14 10 081 90	guarnizione	1	2
8	09 24 03 151 90	ugello	1	2
9	09 31 11 040 90	perno	1	2
10	09 27 97 021-46	rosetta	1	30
11	09 14 10 119 90	guarnizione	1	2
12	90 14 10 049 00 90	guarnizione	1	2
13	05 30 31 025 00 90	set di fissaggio	1	2
14	09 27 97 022-46	rosetta	1	30
15	08 17 20 726 90	sostegno	2	2
16	09 31 11 148 90	perno	2	2
17	09 17 20 023-46	sostegno	1	60

ST 050 608 3979



- boccola del tubo flessibile con manicotto M33
- con anello di fissaggio

	Champagne spazzolato (Oro 22k)	28 285 979-46
	Cromato	28 285 979-00
	Platinato spazzolato	28 285 979-06
	Platinato	28 285 979-08
	Dark Chrome	28 285 979-19
	Ottone spazzolato (Oro 23k)	28 285 979-28
	Nero opaco	28 285 979-33
	Champagne (Oro 22k)	28 285 979-47
	Cromo spazzolato	28 285 979-93
	Dark Platinum spazzolato	28 285 979-99

ST 050 608 3979

mm [inches]



Diagramma di portata



ST 050 608 3979

Parts for other
finishes can be found
here: Cromato

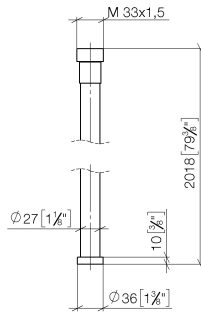
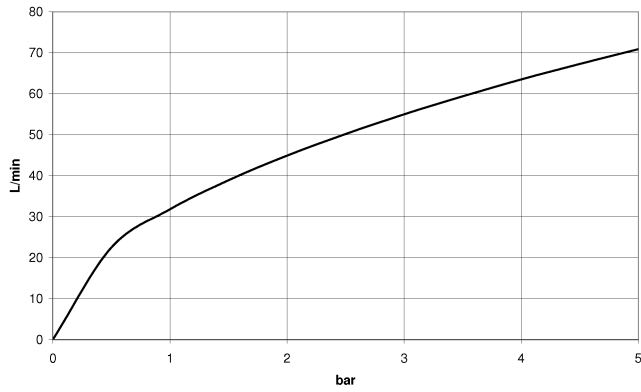