

ST 050 608 4979



Compatibile con: IMO, MEM, CL.1, CYO

- LAMINAR FLOW, portata max. 15 l/min (a 3 bar)
- rosetta 60 x 60 mm
- supporto per tubo flessibile Kneipp
- raccordo curvo 1/2"
- boccia del tubo flessibile con manicotto M33
- con anello di fissaggio

	Champagne spazzolato (Oro 22k)	ST 050 608 4979-46
	Cromato	ST 050 608 4979-00
	Platinato spazzolato	ST 050 608 4979-06
	Platinato	ST 050 608 4979-08
	Dark Chrome	ST 050 608 4979-19
	Ottone spazzolato (Oro 23k)	ST 050 608 4979-28
	Champagne (Oro 22k)	ST 050 608 4979-47
	Cromo spazzolato	ST 050 608 4979-93
	Dark Platinum spazzolato	ST 050 608 4979-99

Componenti singoli di questo set

Per questo set sono necessari i seguenti componenti



1x 27 822 979-46



1x 28 285 979-46

ST 050 608 4979



Compatibile con: IMO, MEM, CL.1, CYO

- Getto laminare
- portata max. l/min (a 3 bar)
- rosetta 60 x 60 mm
- supporto per tubo flessibile Kneipp
- raccordo curvo 1/2"
- senza tubo flessibile

Sistema di sicurezza antiriflusso.

Modifica del prodotto a partire dall'1.4.2023: portata max 15 l/min

	Champagne spazzolato (Oro 22k)	27 822 979-46
	Cromato	27 822 979-00
	Platinato spazzolato	27 822 979-06
	Platinato	27 822 979-08
	Dark Chrome	27 822 979-19
	Ottone spazzolato (Oro 23k)	27 822 979-28
	Nero opaco	27 822 979-33
	Champagne (Oro 22k)	27 822 979-47
	Cromo spazzolato	27 822 979-93
	Dark Platinum spazzolato	27 822 979-99

Prodotti complementari

- | | |
|---|---|
|  | raccordo angolare ad incasso - 35 085 970 90 |
| | ● Profondità d'incasso max. 163 mm |
| | ● profondità d'incasso min. 90 mm |

Prodotti complementari necessari

- | | |
|---|---|
|  | WATER TUBE WATER TUBE tubo flessibile Kneipp bianco 2000 mm - Champagne spazzolato (Oro 22k) 28 285 979-46 |
| | ● con anello di fissaggio |
| | ● boccola del tubo flessibile con manicotto M33 |

Prodotti complementari necessari

- | | |
|---|---|
|  | WATER TUBE WATER TUBE tubo flessibile Kneipp nero 2000 mm - Champagne spazzolato (Oro 22k) 28 286 979-46 |
| | ● con anello di fissaggio |
| | ● boccola del tubo flessibile con manicotto M33 |

ST 050 608 4979

mm [inches]



Diagramma di portata



Certificati

Belgaqua_22_280_2
7_7.

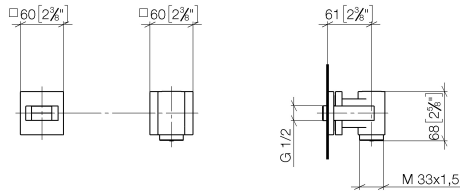
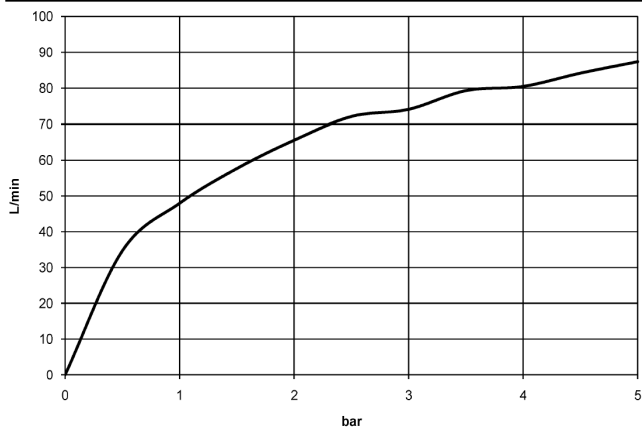
ST 050 608 4979

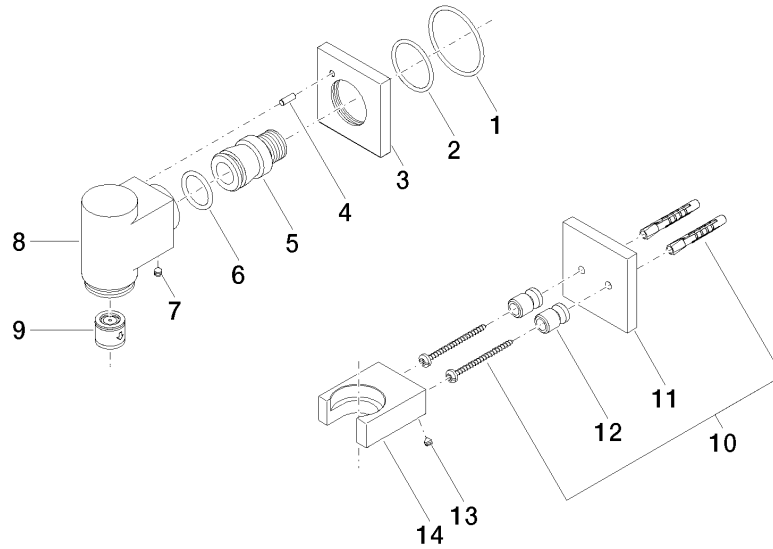

- boccola del tubo flessibile con manicotto M33
- con anello di fissaggio

	Champagne spazzolato (Oro 22k)	28 285 979-46
	Cromato	28 285 979-00
	Platinato spazzolato	28 285 979-06
	Platinato	28 285 979-08
	Dark Chrome	28 285 979-19
	Ottone spazzolato (Oro 23k)	28 285 979-28
	Nero opaco	28 285 979-33
	Champagne (Oro 22k)	28 285 979-47
	Cromo spazzolato	28 285 979-93
	Dark Platinum spazzolato	28 285 979-99

ST 050 608 4979

mm [inches]



Diagramma di portata



ST 050 608 4979

Parts for other
finishes can be found
here: Cromato

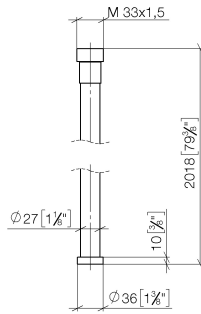
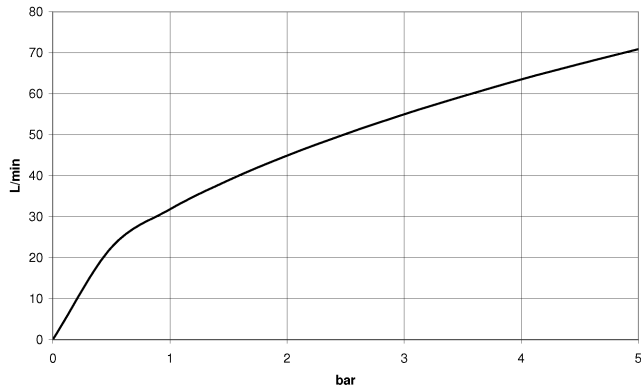