

ST 050 611 6979



Compatibile con: LULU, MADISON, TARA, LISSÉ, VAIA, META

- LAMINAR FLOW, portata max. 15 l/min (a 3 bar)
- rosetta Ø 70 mm
- supporto per tubo flessibile Kneipp
- boccia del tubo flessibile con manicotto M33
- con anello di fissaggio
- raccordo curvo 1/2"

| | | |
|--|--------------------------------|--------------------|
|  | Dark Platinum spazzolato | ST 050 611 6979-99 |
|  | Cromato | ST 050 611 6979-00 |
|  | Platinato spazzolato | ST 050 611 6979-06 |
|  | Platinato | ST 050 611 6979-08 |
|  | Dark Chrome | ST 050 611 6979-19 |
|  | Ottone spazzolato (Oro 23k) | ST 050 611 6979-28 |
|  | Nero opaco | ST 050 611 6979-33 |
|  | Champagne spazzolato (Oro 22k) | ST 050 611 6979-46 |
|  | Champagne (Oro 22k) | ST 050 611 6979-47 |
|  | Cromo spazzolato | ST 050 611 6979-93 |

Componenti singoli di questo set

Per questo set sono necessari i seguenti componenti



1x 27 820 979-99



1x 28 285 979-99

ST 050 611 6979

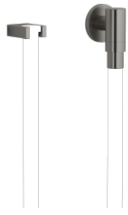

Compatibile con: LULU, MADISON, TARA, LISSÉ, VAIA, META

- LAMINAR FLOW, portata max. 15 l/min (a 3 bar)
- rosetta Ø 70 mm
- supporto per tubo flessibile Kneipp
- raccordo curvo 1/2"
- senza tubo flessibile

Sistema di sicurezza antiriflusso.

Modifica del prodotto a partire dall'1.4.2023: portata max 15 l/min

| | | |
|--|--------------------------------|---------------|
| | Dark Platinum spazzolato | 27 820 979-99 |
| | Cromato | 27 820 979-00 |
| | Platinato spazzolato | 27 820 979-06 |
| | Platinato | 27 820 979-08 |
| | Dark Chrome | 27 820 979-19 |
| | Ottone spazzolato (Oro 23k) | 27 820 979-28 |
| | Nero opaco | 27 820 979-33 |
| | Bronzo spazzolato | 27 820 979-42 |
| | Champagne spazzolato (Oro 22k) | 27 820 979-46 |
| | Champagne (Oro 22k) | 27 820 979-47 |
| | Cromo spazzolato | 27 820 979-93 |

Prodotti complementari necessari



WATER TUBE WATER TUBE tubo flessibile Kneipp bianco 2000 mm - Dark Platinum spazzolato 28 285 979-99

- con anello di fissaggio
- boccia del tubo flessibile con manicotto M33

Prodotti complementari necessari



WATER TUBE WATER TUBE tubo flessibile Kneipp nero 2000 mm - Dark Platinum spazzolato 28 286 979-99

- con anello di fissaggio
- boccia del tubo flessibile con manicotto M33

ST 050 611 6979

mm [inches]



Diagramma di portata



Certificati

Belgaqua_21-381-
27_7.

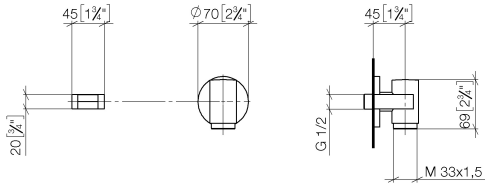
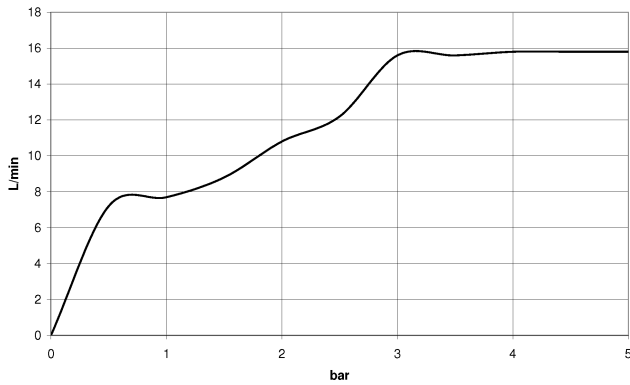
ST 050 611 6979

Parts for other
finishes can be found
here: Cromato

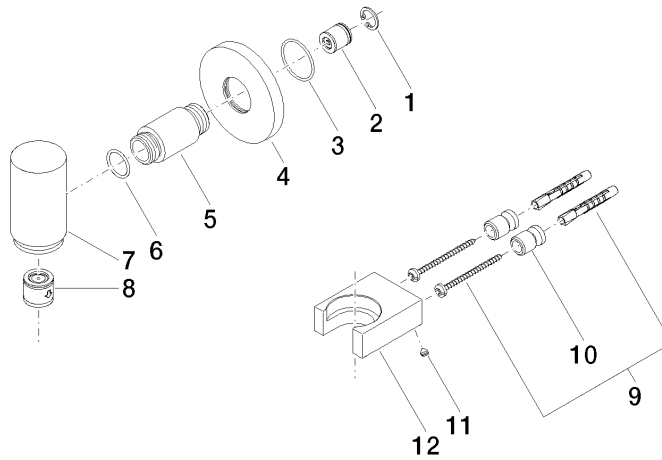

Elenco delle parti di ricambio

| N. | Codice articolo | Denominazione | Quantità necessaria | Tempo di produzione |
|----|--------------------|------------------------|---------------------|---------------------|
| 1 | 09 16 01 014 90 | anello | 1 | 2 |
| 2 | 09 23 01 046 90 | valvola di non ritorno | 1 | 2 |
| 3 | 09 14 10 135 90 | guarnizione | 1 | 2 |
| 4 | 09 27 97 020-99 | rosetta | 1 | 60 |
| 5 | 09 24 04 138-99 | ugello | 1 | 60 |
| 6 | 09 14 10 053 90 | guarnizione | 1 | 2 |
| 7 | 09 11 03 051-99 | attacco | 1 | 30 |
| 8 | 90 23 01 045 00 90 | valvola di non ritorno | 1 | 2 |
| 9 | 05 17 20 726 02 90 | set di fissaggio | 1 | 2 |
| 10 | 08 17 20 726 90 | sostegno | 2 | 2 |
| 11 | 09 31 11 148 90 | perno | 2 | 2 |
| 12 | 09 17 20 023-99 | sostegno | 1 | 60 |

ST 050 611 6979



- boccola del tubo flessibile con manicotto M33
- con anello di fissaggio

| | | |
|--|--------------------------------|---------------|
|  | Dark Platinum spazzolato | 28 285 979-99 |
|  | Cromato | 28 285 979-00 |
|  | Platinato spazzolato | 28 285 979-06 |
|  | Platinato | 28 285 979-08 |
|  | Dark Chrome | 28 285 979-19 |
|  | Ottone spazzolato (Oro 23k) | 28 285 979-28 |
|  | Nero opaco | 28 285 979-33 |
|  | Champagne spazzolato (Oro 22k) | 28 285 979-46 |
|  | Champagne (Oro 22k) | 28 285 979-47 |
|  | Cromo spazzolato | 28 285 979-93 |

ST 050 611 6979

mm [inches]



Diagramma di portata



ST 050 611 6979

Parts for other
finishes can be found
here: Cromato

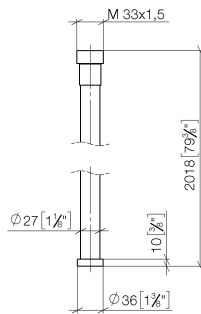
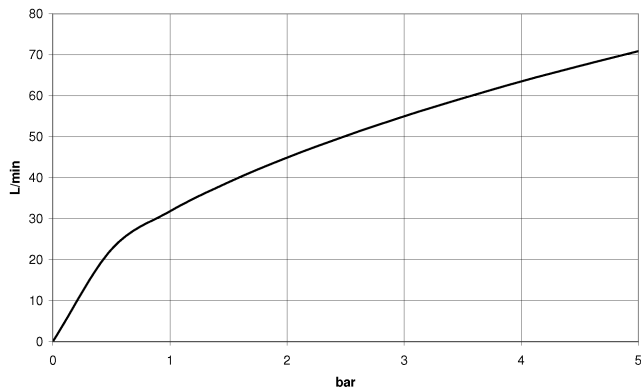
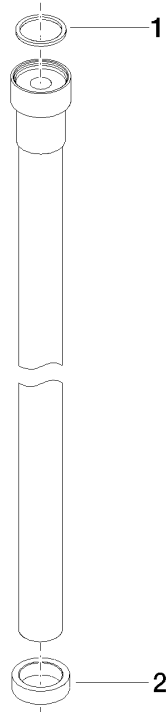

Elenco delle parti di ricambio

| N. | Codice articolo | Denominazione | Quantità necessaria | Tempo di produzione |
|-----------|------------------------|----------------------|----------------------------|----------------------------|
| 1 | 09 14 20 003 90 | guarnizione | 1 | 2 |
| 2 | 09 28 10 116-12 | anello | 1 | 30 |