

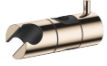







12 580 970

• para diámetro de tubo 18 mm



Encaja con: IMO, LULU, MADISON, MEM,
TARA, CL.1, LISSÉ, VAIA, META, CYO

	Champagne (Oro 22k)	12 580 970-47
	Cromo	12 580 970-00
	Platino cepillado	12 580 970-06
	Platino	12 580 970-08
	Latón (Oro 23k)	12 580 970-09
	Dark Chrome	12 580 970-19
	Oro claro	12 580 970-26
	Oro claro cepillado	12 580 970-27
	Latón cepillado (Oro 23k)	12 580 970-28
	Negro mate	12 580 970-33
	Bronce cepillado	12 580 970-42
	Champagne cepillado (Oro 22k)	12 580 970-46
	Cromo cepillado	12 580 970-93
	Dark Platinum cepillado	12 580 970-99

12 580 970

mm [inches]

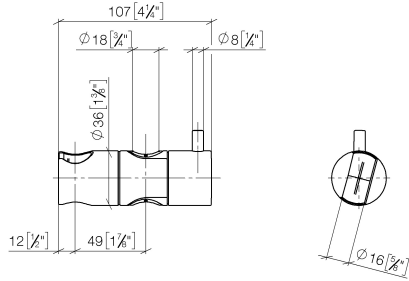

12 580 970

Versión del producto de 10/1/2023

Piezas para otros
acabados pueden
encontrarse aquí:
Cromo

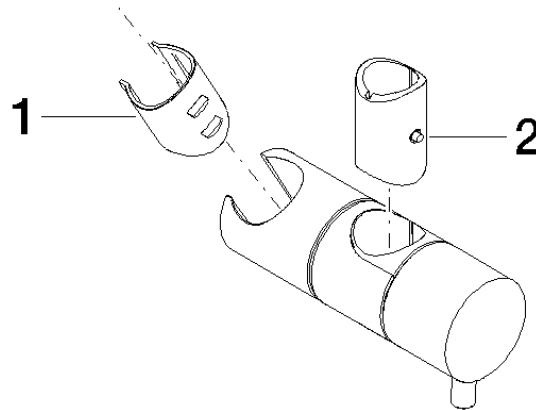



Soporte deslizante - Champagne (Oro 22k)

IMO

12 580 970

Lista de piezas de recambios

Versión del producto de 10/1/2023

N°	Número de artículo	Denominación	Cantidad de montaje	Plazo de entrega
	09 12 12 217 90	camisa	2	2