



























28 508 979



- Saliente 200 mm
- Articulación esférica giratoria 30°
- Ajustable en tres posiciones: PURIFY RAIN, COMPACT SOFT FLOW, COMPACT AQUAPRESSURE FLOW, caudal máx. 9 l/min (a 3 bares)
- Función de: 7 l/min
- Con sistema antical
- Alcahofa de ducha Ø 92mm
- Roseta Ø 55 mm
- Racor 1/2"

Encaja con: TARA, LISSÉ, VAIA, META

	Cromo	28 508 979-00
	Cromo	28 508 979-00 0010
	Platino cepillado	28 508 979-06 0010
	Platino cepillado	28 508 979-06
	Platino	28 508 979-08 0010
	Platino	28 508 979-08
	Dark Chrome	28 508 979-19 0010
	Dark Chrome	28 508 979-19
	Oro claro	28 508 979-26 0010
	Oro claro	28 508 979-26
	Oro claro cepillado	28 508 979-27 0010
	Oro claro cepillado	28 508 979-27
	Latón cepillado (Oro 23k)	28 508 979-28 0010
	Latón cepillado (Oro 23k)	28 508 979-28
	Negro mate	28 508 979-33 0010
	Negro mate	28 508 979-33
	Bronce cepillado	28 508 979-42 0010
	Bronce cepillado	28 508 979-42
	Champagne cepillado (Oro 22k)	28 508 979-46 0010
	Champagne cepillado (Oro 22k)	28 508 979-46
	Champagne (Oro 22k)	28 508 979-47 0010
	Champagne (Oro 22k)	28 508 979-47
	Cromo cepillado	28 508 979-93 0010
	Cromo cepillado	28 508 979-93
	Dark Platinum cepillado	28 508 979-99 0010
	Dark Platinum cepillado	28 508 979-99

28 508 979

Complementos recomendados



Cuerpo empotrado -

35 085 970 90

- Profundidad de montaje máx. 163 mm
- Profundidad de montaje mín. 90 mm

28 508 979

mm [inches]



Diagrama de flujo



Versión del producto de 6/1/2024



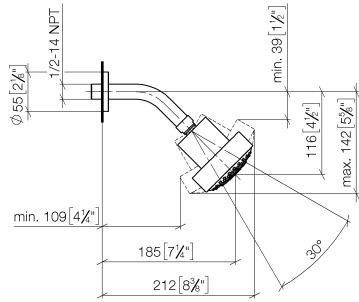
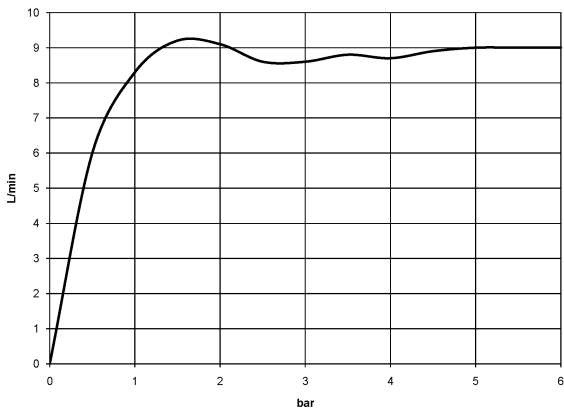
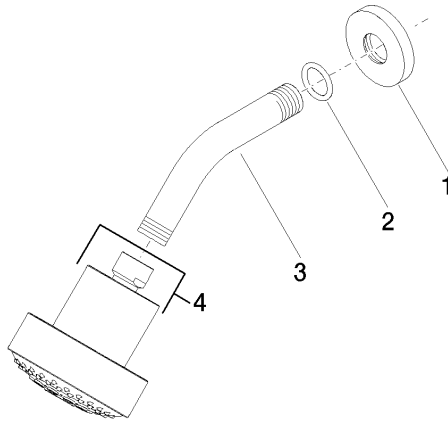

Ducha fija - Cromo

TARA

28 508 979

Lista de piezas de recambios

Versión del producto de 6/1/2024

N°	Número de artículo	Denominación	Cantidad de montaje	Plazo de entrega
	09 27 22 003-00	roseta	4	10