

36 112 970



Encaja con: IMO, LULU, TARA, LISSÉ, VAIA, META

- Saliente ducha de pie 450 mm
- Ducha de cabeza: Chorro de lluvia
- Ø Ducha de lluvia 220 mm
- Ducha efecto lluvia con sistema antical
- Caudal ducha de lluvia máx. 14 l/min
- Altura de la grifería hasta el ducha de lluvia (extremo inferior): 1010mm
- Altura de la grifería hasta el extremo superior del codo 1150mm
- Flexo metálico 1750mm con bloqueo de giro integrado
- Racor 1/2"
- Barra a pared con soporte deslizante
- Diámetro de tubo 23,5 mm
- Inversor automático Ducha de pie/ Ducha de mano
- Con función de marcha en vacío

**Ester artículo no incluye ducha de mano!**

**Protección contra reflujo.**

Ester artículo no incluye ducha de mano!

Protección contra reflujo.

	Cromo	36 112 970-00
	Platino cepillado	36 112 970-06
	Platino	36 112 970-08
	Dark Chrome	36 112 970-19
	Oro claro cepillado	36 112 970-27
	Latón cepillado (Oro 23k)	36 112 970-28
	Negro mate	36 112 970-33
	Bronce cepillado	36 112 970-42
	Champagne cepillado (Oro 22k)	36 112 970-46
	Champagne (Oro 22k)	36 112 970-47
	Cromo cepillado	36 112 970-93
	Dark Platinum cepillado	36 112 970-99

36 112 970

**Complementos necesarios**

	<b>Fijación mural empotrada -</b> ●Profundidad de montaje máx. 105 mm ●Profundidad de montaje mín. 80 mm	35 050 970 90
---	--	---------------

**Complementos necesarios**

	<b>Ducha de mano FlowReduce - Cromo</b>	28 012 979-00 0010
---	---	--------------------

**Complementos necesarios**

	<b>Ducha de mano - Cromo</b>	28 016 979-00
---	------------------------------	---------------

**Complementos necesarios**

	<b>Ducha de mano - Cromo</b>	28 018 979-00
---	------------------------------	---------------

**Complementos necesarios**

	<b>GENÉRICOS Ducha de mano - Cromo</b>	28 029 979-00 0010
---	--	--------------------

**Complementos necesarios**

	<b>GENÉRICOS Ducha de mano - Cromo</b>	28 025 979-00 0010
---	--	--------------------

**Complementos necesarios**

	<b>Ducha de mano FlowReduce - Cromo</b>	28 016 979-00 0010
---	---	--------------------

**Complementos necesarios**

	<b>Ducha de mano - Cromo</b>	28 017 979-00
---	------------------------------	---------------

**Complementos necesarios**

	<b>Ducha de mano - Cromo</b>	28 012 979-00
---	------------------------------	---------------

**Complementos necesarios**

	<b>Ducha de mano FlowReduce - Cromo</b>	28 018 979-00 0010
---	---	--------------------

**Complementos necesarios**

	<b>GENÉRICOS Ducha de mano - Cromo</b>	28 029 979-00
---	--	---------------

**Complementos necesarios**

	<b>GENÉRICOS Ducha de mano - Cromo</b>	28 027 979-00 0010
---	--	--------------------

36 112 970

mm [inches]  
1:10



Diagrama de flujo



Códigos y Estándares

DIN 4109

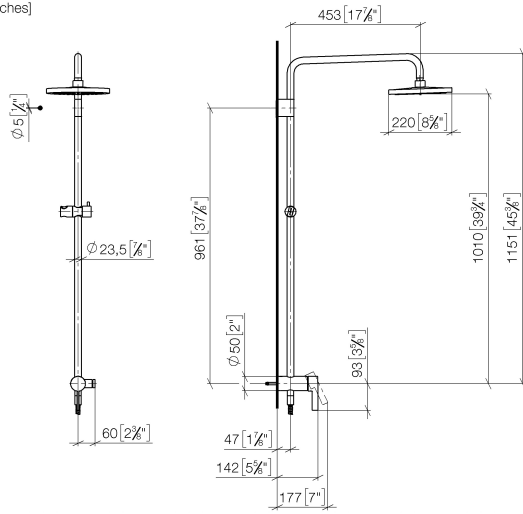
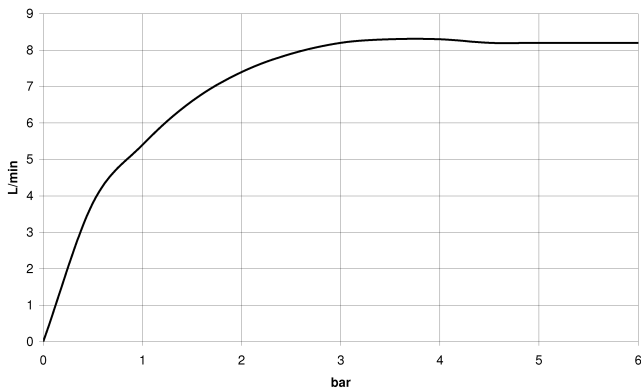
EN 1717

EN 817

ISO 3822

Scottish Water  
Byelaws

UK Water Supply  
Regulations

Ü-Zeichen



Showerpipe con monomando de ducha sin ducha de mano - Cromo

IMO

36 112 970

Certificado

DVGW\_DW-  
6512DN0

Belgaqua\_21-025-2 LGA\_38

WRAS\_2101

36 112 970

Versión del producto de 4/1/2024





## Showerpipe con monomando de ducha sin ducha de mano - Cromo

IMO

36 112 970

### Lista de piezas de recambios

Versión del producto de 4/1/2024

N°	Número de artículo	Denominación	Cantidad de montaje	Plazo de entrega
	04 12 05 092 00-00	duchas	9	10