

36 517 979

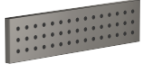

- HORIZONTAL RAIN, caudal máx. 6 l/min (a 3 bares)
- Con sistema antical
- Cubierta 240 x 60 mm
- Racor 1/2"
- Este producto puede ayudar a un edificio a cumplir con los requisitos de los sistemas de certificación ecológica de edificios: LEED®, BREEAM®, DGNB

Encaja con: IMO, LULU, MADISON, MEM, TARA, CL.1, LISSÉ, VAIA, META, CYO

	Dark Platinum cepillado	36 517 979-99
	Cromo	36 517 979-00
	Platino cepillado	36 517 979-06
	Platino	36 517 979-08
	Dark Chrome	36 517 979-19
	Oro claro	36 517 979-26
	Oro claro cepillado	36 517 979-27
	Latón cepillado (Oro 23k)	36 517 979-28
	Negro mate	36 517 979-33
	Bronce cepillado	36 517 979-42
	Champagne cepillado (Oro 22k)	36 517 979-46
	Champagne (Oro 22k)	36 517 979-47
	Cromo cepillado	36 517 979-93

Complementos necesarios

	Caja de montaje a pared empotrada - ●Profundidad de montaje máx. 173 mm ●Profundidad de montaje mín. 100 mm	35 206 970 90
---	--	---------------

Complementos necesarios

	xGRID Carril de montaje 555 mm -	12 360 970 90
---	---	---------------

Complementos recomendados

	xGRID Juego de fijación para integración en obra en seco -	12 340 970 90
---	---	---------------

36 517 979

mm [inches]



Diagrama de flujo



Diagrama de trayectoria

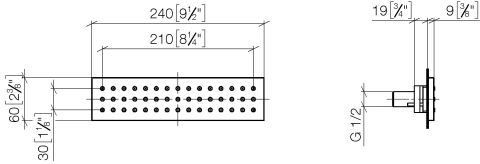

Códigos y Estándares

DIN 4109

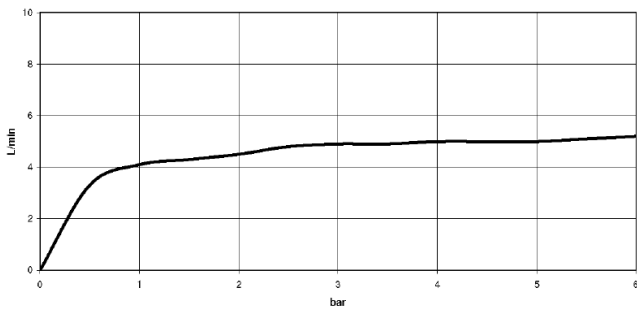
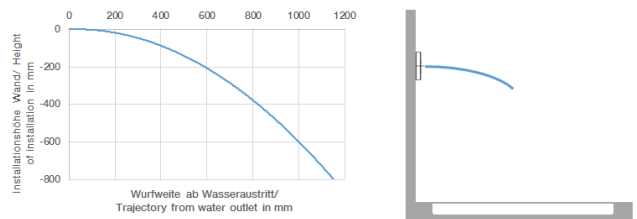
ISO 3822

Scottish Water
Byelaws

UK Water Supply
Regulations

Ü-Zeichen



WATER BAR Ducha lateral empotrada FlowReduce - Dark Platinum cepillado

IMO

36 517 979

Certificado

LGA_19

WRAS_1304

36 517 979

Versión del producto hasta 5/15/2020

Versión del producto de 5/15/2020 a 5/16/2020

Versión del producto de 5/16/2020

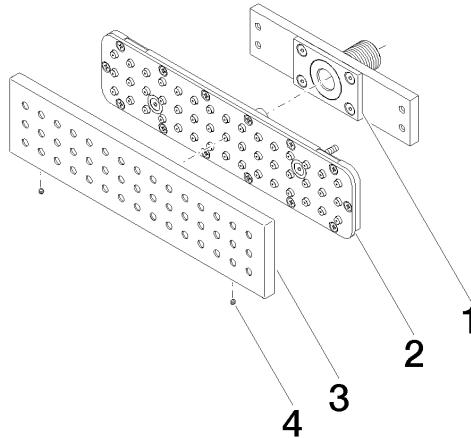



WATER BAR Ducha lateral empotrada FlowReduce - Dark Platinum cepillado

IMO

36 517 979

Lista de piezas de recambios

Versión del producto hasta 5/15/2020

Versión del producto de 5/15/2020 a 5/16/2020

Versión del producto de 5/16/2020

Nº	Número de artículo	Denominación	Cantidad de montaje	Plazo de entrega
	90 11 02 137 00 90	racor	4	2