

36 527 979

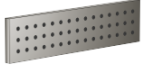

- HORIZONTAL RAIN, caudal máx. 9 l/min (a 3 bares)
- Con sistema antical
- Cubierta 240 x 60 mm
- Racor 1/2"

Encaja con: IMO, LULU, MADISON, MEM, TARA, CL.1, LISSÉ, VAIA, META, CYO

	Dark Chrome	36 527 979-19
	Cromo	36 527 979-00
	Platino cepillado	36 527 979-06
	Platino	36 527 979-08
	Oro claro	36 527 979-26
	Oro claro cepillado	36 527 979-27
	Latón cepillado (Oro 23k)	36 527 979-28
	Negro mate	36 527 979-33
	Bronce cepillado	36 527 979-42
	Champagne cepillado (Oro 22k)	36 527 979-46
	Champagne (Oro 22k)	36 527 979-47
	Cromo cepillado	36 527 979-93
	Dark Platinum cepillado	36 527 979-99

Complementos necesarios

	Caja de montaje a pared empotrada - ● Profundidad de montaje máx. 173 mm ● Profundidad de montaje mín. 100 mm	35 206 970 90
---	--	---------------

Complementos necesarios

	xGRID Carril de montaje 555 mm -	12 360 970 90
---	---	---------------

Complementos recomendados

	xGRID Juego de fijación para integración en obra en seco -	12 340 970 90
---	---	---------------

36 527 979

mm [inches]



Diagrama de flujo



Códigos y Estándares

DIN 4109

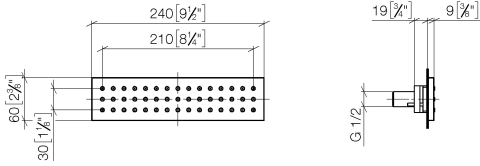
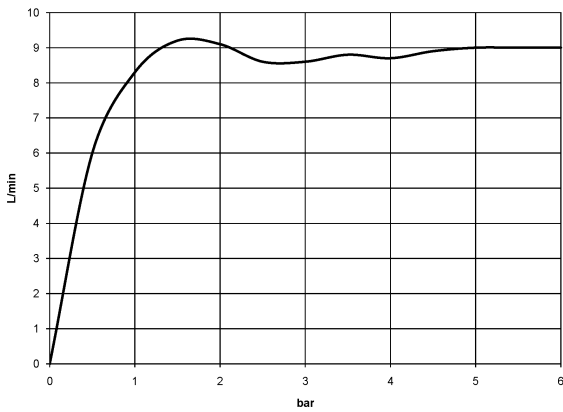
ISO 3822

Ü-Zeichen



WATER BAR Ducha lateral empotrada - Dark Chrome

IMO

36 527 979

Certificado

LGA_38

36 527 979

Versión del producto de 10/1/2023

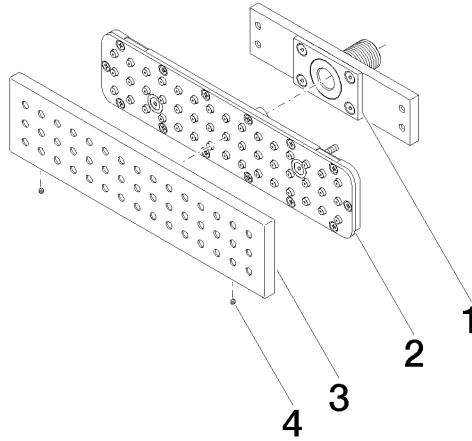



WATER BAR Ducha lateral empotrada - Dark Chrome

IMO

36 527 979

Lista de piezas de recambios

Versión del producto de 10/1/2023

N°	Número de artículo	Denominación	Cantidad de montaje	Plazo de entrega
	90 11 02 137 00 90	racor	5	2