







CL.1 Llave de paso empotrada cierre a la derecha frío 1/2" - Cromo

36 607 706 Versión del producto de 10/14/2020



- Roseta 60 x 60 mm
- Con distintivo fría
- Montura con husillo ajustable y camisa

	Cromo	36 607 706-00
	Platino cepillado	36 607 706-06
	Dark Chrome	36 607 706-19
	Champagne cepillado (Oro 22k)	36 607 706-46
	Champagne (Oro 22k)	36 607 706-47
	Dark Platinum cepillado	36 607 706-99

Complementos necesarios



- Válvula empotrada 1/2" -** 35 607 970 90
- Profundidad de montaje máx. mm
 - Profundidad de montaje mín. mm

CL.1 Llave de paso empotrada cierre a la derecha frío 1/2" - Cromo

36 607 706 Versión del producto de 10/14/2020

mm [inches]

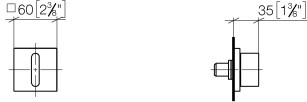

Códigos y Estándares

ASME A112.18.1	cUPC	DIN 4109	EN 200
ISO 3822	Scottish Water Byelaws	UK Water Supply Regulations	Ü-Zeichen

Certificado

DVGW_DW-6501DN0	LGA_29	WRAS_2010	LGA_29	IAPMO_4976 (
-----------------	--------	-----------	--------	--------------

CL.1 Llave de paso empotrada cierre a la derecha frío 1/2" - Cromo

36 607 706 Versión del producto de 10/14/2020

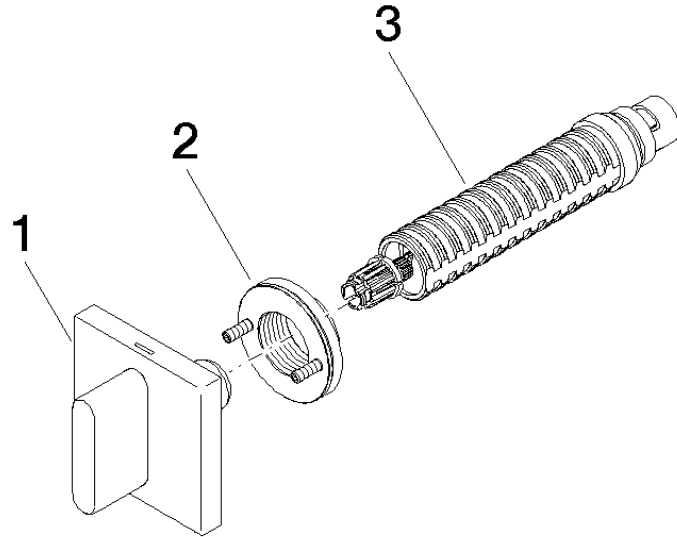

Lista de piezas de recambios

N°	Número de artículo	Denominación	Cantidad de montaje	Plazo de entrega
1	90 20 70 051 02-00	manilla (cold)	1	10
2	90 21 02 108 00 90	disco	1	2
3	90 90 03 143 00 90	parte superior	1	2