







CL.1 Llave de paso empotrada cierre a la derecha 3/4" - Platino cepillado

36 628 705 Versión del producto de 10/14/2020



- Con estructura CASCADA
- Roseta 60 x 60 mm
- Sin distintivo
- Montura con husillo ajustable y camisa

	Platino cepillado	36 628 705-06
	Cromo	36 628 705-00
	Dark Chrome	36 628 705-19
	Champagne cepillado (Oro 22k)	36 628 705-46
	Champagne (Oro 22k)	36 628 705-47
	Dark Platinum cepillado	36 628 705-99

Complementos necesarios

	Válvula empotrada 3/4" -	35 608 970 90
	<ul style="list-style-type: none"> • Profundidad de montaje máx. mm • Profundidad de montaje mín. mm 	

CL.1 Llave de paso empotrada cierre a la derecha 3/4" - Platino cepillado

36 628 705 Versión del producto de 10/14/2020

mm [inches]

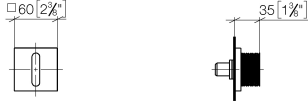

Códigos y Estándares

ASME A112.18.1

cUPC

Scottish Water
Byelaws

UK Water Supply
Regulations

Certificado

WRAS_2010

IAPMO_4976 (

CL.1 Llave de paso empotrada cierre a la derecha 3/4" - Platino cepillado

36 628 705 Versión del producto de 10/14/2020

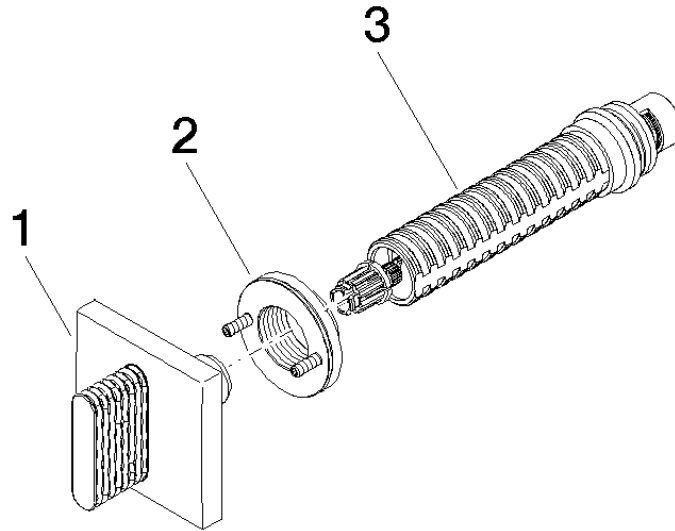

Lista de piezas de recambios

N°	Número de artículo	Denominación	Cantidad de montaje	Plazo de entrega
1	90 20 70 053 01-06	manilla	1	10
2	90 21 02 108 00 90	disco	1	2
3	90 90 03 127 00 90	parte superior	1	2