



## EDITION PRO Soporte para papel higiénico con cubierta - Cromo

---

83 510 626



- Ancho 150mm
- Altura 95 mm
- Roseta Ø 40 mm
- Saliente 40 mm

	Cromo	83 510 626-00
	Negro mate	83 510 626-33
	Cromo cepillado	83 510 626-93



# EDITION PRO Soporte para papel higiénico con cubierta - Cromo

83 510 626

mm [inches]

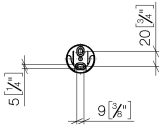
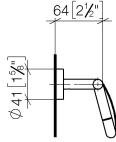
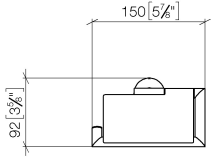

EDITION PRO Soporte para papel higiénico con cubierta - Cromo

83 510 626

Piezas para otros  
acabados pueden  
encontrarse aquí:  
Negro mate

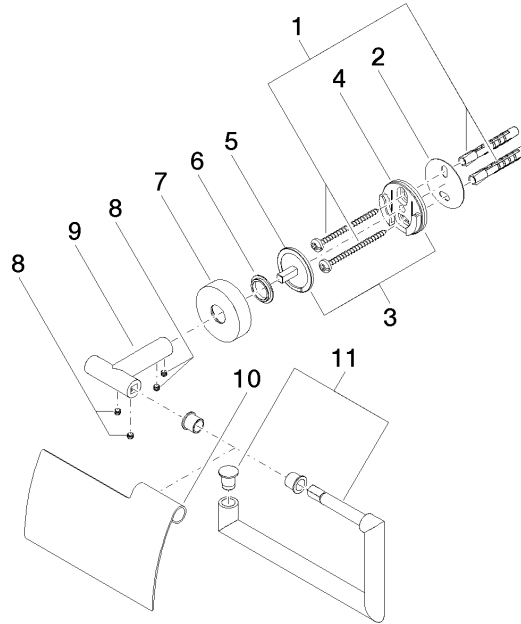



## EDITION PRO Soporte para papel higiénico con cubierta - Cromo

---

83 510 626

### Lista de piezas de recambios

N°	Número de artículo	Denominación	Cantidad de montaje	Plazo de entrega
	05 30 31 025 00 90	juego de fijación	14	2