

ST 050 203 2979



Encaja con: IMO, LISSÉ, META

- Barra a pared con soporte deslizante
- Diámetro de tubo 18 mm
- Calibración 853 mm
- Flexo metálico 1750mm con bloqueo de giro integrado
- Conexión para flexo de ducha 3/8"
- Ajustable en tres o bien cinco posiciones: COMPACT RAIN, COMPACT SOFT FLOW, COMPACT AQUAPRESSURE FLOW, caudal máx. 6,8 l/min (a 3 bares)
- Función de: 6 l/min
- Alcachofa de ducha Ø 100mm
- Este producto puede ayudar a un edificio a cumplir con los requisitos de los sistemas de certificación ecológica de edificios: LEED®, BREEAM®, DGNB

	Cromo	ST 050 203 2979-00 0010
	Cromo	ST 050 203 9979-00
	Platino cepillado	ST 050 203 9979-06
	Platino cepillado	ST 050 203 2979-06 0010
	Platino	ST 050 203 9979-08
	Platino	ST 050 203 2979-08 0010
	Dark Chrome	ST 050 203 9979-19
	Dark Chrome	ST 050 203 2979-19 0010
	Oro claro	ST 050 203 2979-26 0010
	Oro claro	ST 050 203 9979-26
	Oro claro cepillado	ST 050 203 9979-27
	Oro claro cepillado	ST 050 203 2979-27 0010
	Latón cepillado (Oro 23k)	ST 050 203 9979-28
	Latón cepillado (Oro 23k)	ST 050 203 2979-28 0010
	Negro mate	ST 050 203 9979-33
	Negro mate	ST 050 203 2979-33 0010
	Bronce cepillado	ST 050 203 9979-42
	Bronce cepillado	ST 050 203 2979-42 0010
	Champagne cepillado (Oro 22k)	ST 050 203 9979-46
	Champagne cepillado (Oro 22k)	ST 050 203 2979-46 0010
	Champagne (Oro 22k)	ST 050 203 9979-47
	Champagne (Oro 22k)	ST 050 203 2979-47 0010
	Cromo cepillado	ST 050 203 9979-93
	Cromo cepillado	ST 050 203 2979-93 0010
	Dark Platinum cepillado	ST 050 203 9979-99
	Dark Platinum cepillado	ST 050 203 2979-99 0010

ST 050 203 2979

Componentes individuales de este set

Necesita los siguientes componentes para este set



1x 26 413 979-00



1x 28 018 979-00 0010



ST 050 203 2979



Encaja con: IMO, LULU, MEM, TARA, CL.1,  
LISSÉ, VAIA, META, CYO

- Barra a pared con soporte deslizante
- Diámetro de tubo 18 mm
- Calibración 853 mm
- Flexo metálico 1750mm con bloqueo de giro integrado
- Conexión para flexo de ducha 3/8"

Ester artículo no incluye ducha de mano!

	Cromo	26 413 979-00
	Platino cepillado	26 413 979-06
	Platino	26 413 979-08
	Dark Chrome	26 413 979-19
	Oro claro	26 413 979-26
	Oro claro cepillado	26 413 979-27
	Latón cepillado (Oro 23k)	26 413 979-28
	Negro mate	26 413 979-33
	Bronce cepillado	26 413 979-42
	Champagne cepillado (Oro 22k)	26 413 979-46
	Champagne (Oro 22k)	26 413 979-47
	Cromo cepillado	26 413 979-93
	Dark Platinum cepillado	26 413 979-99

ST 050 203 2979

Complementos recomendados

	<b>Cuerpo empotrado -</b> ●Profundidad de montaje máx. 163 mm ●Profundidad de montaje mín. 90 mm	35 085 970 90
---	--	---------------

Complementos recomendados

	<b>LISSE Codo de conexión a pared - Cromo</b>	28 450 845-00
---	---	---------------

Complementos necesarios

	<b>Ducha de mano FlowReduce - Cromo</b> ●Caudal máx. 6,8 l/min (a 3 bares)	28 016 979-00 0010
---	---	-----------------------

Complementos necesarios

	<b>Ducha de mano - Cromo</b> ●Caudal máx. 15 l/min (a 3 bares)	28 017 979-00
---	---	---------------

Complementos necesarios

	<b>Ducha de mano - Cromo</b> ●Caudal máx. 15 l/min (a 3 bares)	28 012 979-00
---	---	---------------

Complementos necesarios

	<b>Ducha de mano FlowReduce - Cromo</b> ●Caudal máx. 6,8 l/min (a 3 bares)	28 018 979-00 0010
---	---	-----------------------

Complementos recomendados

	<b>Codo de conexión a pared - Cromo</b>	28 450 980-00
---	---	---------------

Complementos necesarios

	<b>Ducha de mano - Cromo</b> ●Caudal máx. 15 l/min (a 3 bares)	28 015 979-00
---	---	---------------

Complementos necesarios

	<b>Ducha de mano FlowReduce - Cromo</b> ●Caudal máx. 6,8 l/min (a 3 bares)	28 012 979-00 0010
---	---	-----------------------

Complementos necesarios

	<b>Ducha de mano - Cromo</b> ●Caudal máx. 15 l/min (a 3 bares)	28 016 979-00
---	---	---------------

Complementos necesarios

	<b>Ducha de mano - Cromo</b> ●Caudal máx. 15 l/min (a 3 bares)	28 018 979-00
---	---	---------------



ST 050 203 2979

mm [inches]

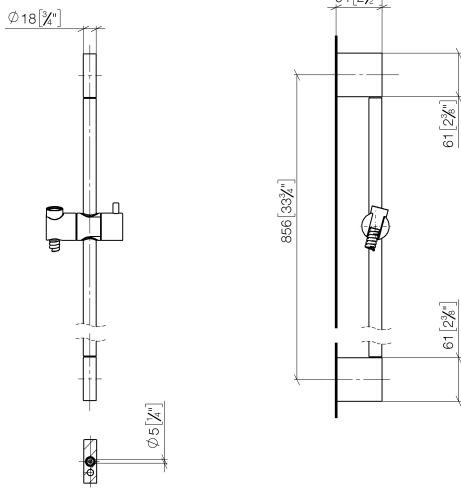

Certificado

WRAS\_2009048. ACS\_20 ACC LY 738. IAPMO\_4976 (1).

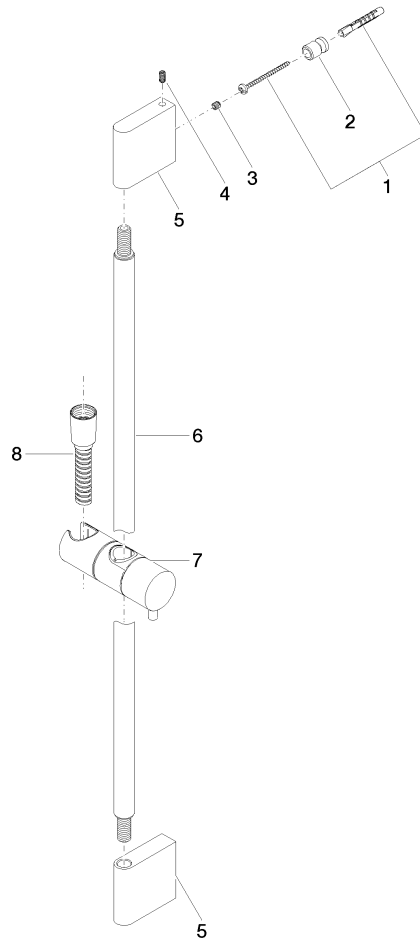

**Lista de piezas de recambios**

N°	Número de artículo	Denominación	Cantidad de montaje	Plazo de entrega
1	05 17 20 726 02 90	juego de fijación	2	2
2	08 17 20 726 90	soporte	2	2
3	09 31 11 049 90	varilla	2	2
4	04 31 11 113 00 90	varilla	2	2
5	08 17 97 054-00	soporte	2	10
6	90 28 22 597 00-00	soporte	1	10
7	12 580 970-00	Soporte deslizante - Cromo	1	10
8	28 322 970-00	Flexo de ducha metálico 1/2" x 3/8" x 1750 mm - Cromo	1	2



ST 050 203 2979



- Ajustable en tres o bien cinco posiciones: COMPACT RAIN, COMPACT SOFT FLOW, COMPACT AQUAPRESSURE FLOW, caudal máx. 6,8 l/min (a 3 bares)
- Con sistema antical
- Alcachofa de ducha Ø 100mm
- Racor 1/2"
- Función de: 6 l/min
- Este producto puede ayudar a un edificio a cumplir con los requisitos de los sistemas de certificación ecológica de edificios: LEED®, BREEAM®, DGNB

Encaja con: IMO, LULU, MADISON, MEM, TARA, CL.1, LISSÉ, VAIA, META, CYO

Protección contra reflujo.

	Cromo	28 018 979-00 0010
	Cromo	28 018 979-00
	Platino cepillado	28 018 979-06
	Platino cepillado	28 018 979-06 0010
	Platino	28 018 979-08
	Platino	28 018 979-08 0010
	Dark Brass matt	28 018 979-16 0010
	Dark Bronze matt	28 018 979-17 0010
	Dark Chrome	28 018 979-19
	Dark Chrome	28 018 979-19 0010
	Oro claro	28 018 979-26 0010
	Oro claro	28 018 979-26
	Oro claro cepillado	28 018 979-27 0010
	Oro claro cepillado	28 018 979-27
	Latón cepillado (Oro 23k)	28 018 979-28
	Latón cepillado (Oro 23k)	28 018 979-28 0010
	Negro mate	28 018 979-33
	Negro mate	28 018 979-33 0010
	Bronce cepillado	28 018 979-42 0010
	Bronce cepillado	28 018 979-42
	Champagne cepillado (Oro 22k)	28 018 979-46
	Champagne cepillado (Oro 22k)	28 018 979-46 0010
	Champagne (Oro 22k)	28 018 979-47
	Champagne (Oro 22k)	28 018 979-47 0010
	Cromo cepillado	28 018 979-93
	Cromo cepillado	28 018 979-93 0010
	Dark Platinum cepillado	28 018 979-99
	Dark Platinum cepillado	28 018 979-99 0010







ST 050 203 2979

mm [inches]



Diagrama de flujo



Certificado

LGA\_29984.

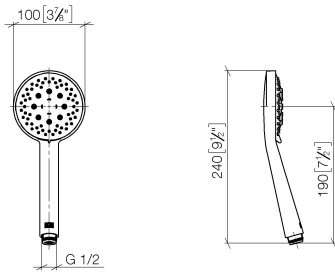
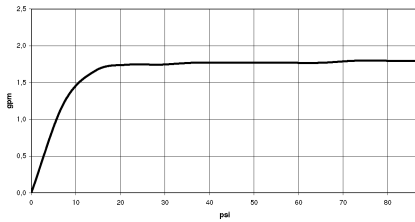
Lista de piezas de recambios

N°	Número de artículo	Denominación	Cantidad de montaje	Plazo de entrega
1	09 23 01 039 90	tamiz	1	2