











**META Bath spout without diverter for free-standing assembly - Brushed  
Champagne (22kt Gold)**

META

13 672 661



- 282mm projection
- circular normal flow
- total height 811 - 881 mm
- height up to aerator 671 – 741 mm
- slide-on rosettes Ø 135 mm
- max. flow 28.6 l/min at 3 bar flow pressure

	Brushed Champagne (22kt Gold)	13 672 661-46
	Chrome	13 672 661-00
	Brushed Platinum	13 672 661-06
	Dark Chrome	13 672 661-19
	Light Gold	13 672 661-26
	Brushed Light Gold	13 672 661-27
	Matte Black	13 672 661-33
	Brushed Bronze	13 672 661-42
	Champagne (22kt Gold)	13 672 661-47
	Brushed Chrome	13 672 661-93
	Brushed Dark Platinum	13 672 661-99

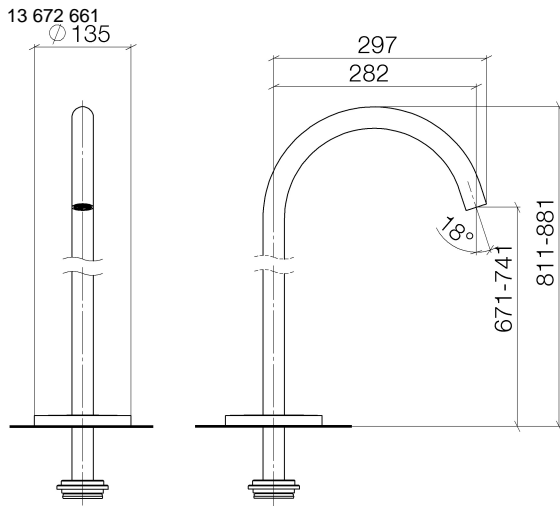

**Flow rate chart**

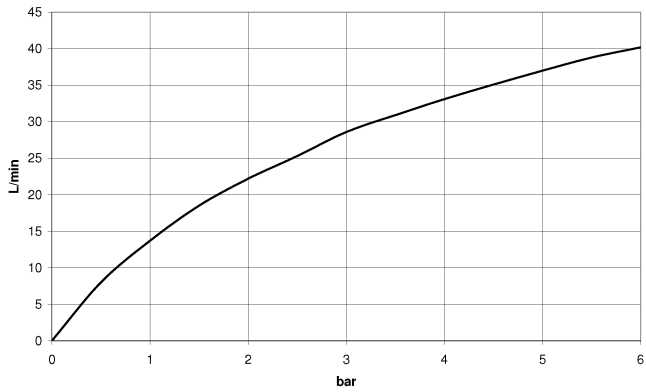

13 672 661  
Parts for other  
finishes can be found  
here: [Chrome](#)

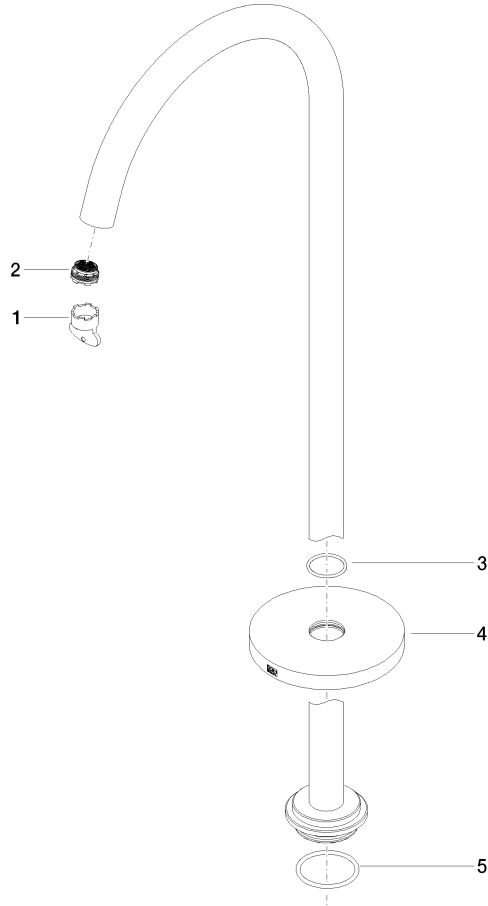

**Spare parts list**

No.	Item Number	Name	Quantity used	Delivery time
1	04 30 09 027 00 90	key	1	2
2	09 29 03 127 90	aerator	1	60
3	09 14 10 101 90	seal	1	2
4	09 27 85 003-46	rosette	1	60
5	09 14 10 084 90	seal	1	2