

**VAIA Two-hole bath mixer for free-standing assembly with hand shower set -
Brushed Bronze**









VAIA

25 943 819



- spout: circular, air-enriched flow
 - max. flow 24.6 l/min at 3 bar flow pressure
 - Hand shower: COMPACT RAIN, max. flow rate 6.8 l/min (at 3 bar)
 - hand shower with anti-scale system
 - 221mm projection
 - pivotable spout 360°
 - rotary diverter for bath/shower
 - total height 920 mm
 - stand pipes height 628 mm
 - height up to aerator 816 mm
 - slide-on rosettes Ø 100 mm
 - gauge 150 mm
 - metal shower hose 1250mm with integrated anti-twist protection
 - pivotable shower holder on the right foot
- Intrinsic protection against back flow.**

Intrinsic protection against back flow.

	Brushed Bronze	25 943 819-42
	Chrome	25 943 819-00
	Brushed Platinum	25 943 819-06
	Platinum	25 943 819-08
	Dark Chrome	25 943 819-19
	Brushed Durabronze (23kt Gold)	25 943 819-28
	Brushed Champagne (22kt Gold)	25 943 819-46
	Champagne (22kt Gold)	25 943 819-47
	Brushed Dark Platinum	25 943 819-99

Required miscellaneous



Concealed floor mounting -

35 944 970 90

- min. recess depth 80 mm
- max. recess depth 160 mm

**VAIA Two-hole bath mixer for free-standing assembly with hand shower set -
Brushed Bronze**

VAIA

25 943 819
mm [inches]

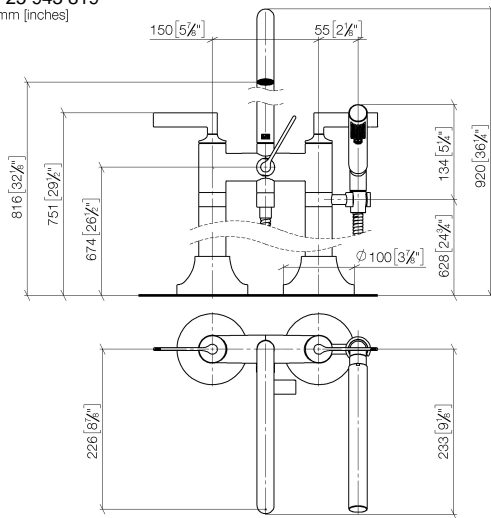

Flow rate chart

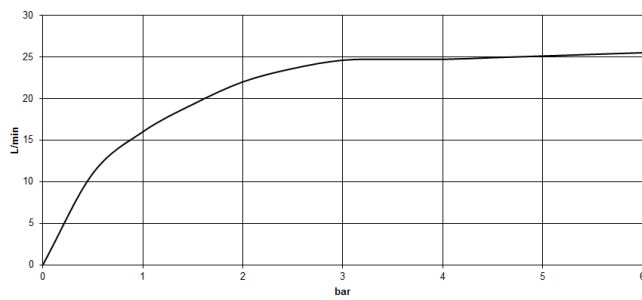

Certificates

Belgauqa_22_276_2 LGA_29294.
7_2.

VAIA Two-hole bath mixer for free-standing assembly with hand shower set -
Brushed Bronze

VAIA

25 943 819

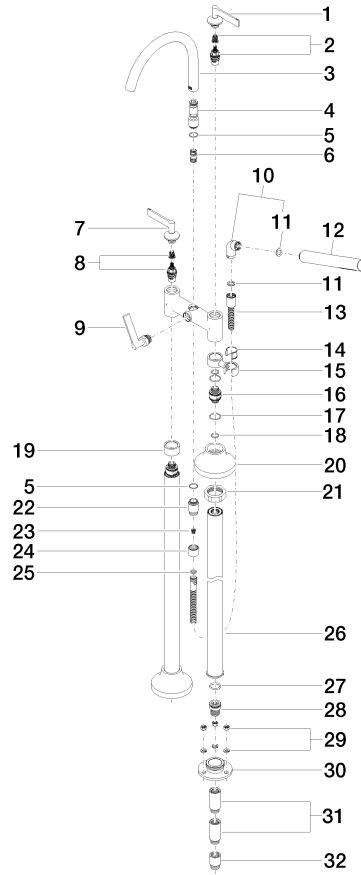



VAIA Two-hole bath mixer for free-standing assembly with hand shower set - Brushed Bronze

VAIA

25 943 819

Spare parts list

No.	Item Number	Name	Quantity used	Delivery time
1	90 20 80 012 01-42	handle (cold)	1	30
2	90 90 03 130 00 90	top	1	2
3	90 28 22 317 00-42	spout	1	30
4	09 24 03 273-42	nipple	1	60
5	90 14 10 032 00 90	seal	1	2
6	90 21 10 011 00 90	diverter	1	2
7	90 20 80 013 01-42	handle (hot)	1	30
8	90 90 03 131 00 90	top	1	2
9	90 20 80 015 02-42	handle	1	30
10	04 24 04 189 00-42	nipple	1	60
11	90 14 20 002 00 90	seal	1	2
12	90 12 11 140 30-42	shower	1	30
13	90 30 02 072 00-42	hose	1	30
14	90 18 40 035 00 90	sleeve	1	2
15	04 28 10 029 01-42	holder	1	60
16	09 29 05 021 20 90	nipple	2	2
17	09 14 10 112 90	seal	4	2
18	90 14 10 055 00 90	seal	4	2
19	09 28 10 028-42	sleeve	1	60
20	90 27 80 019 00-42	rosette	2	30
21	09 23 30 040-07	nut	2	30
22	09 24 03 121-42	nipple	1	60
23	09 23 01 131 90	back-flow preventer	1	2
24	09 21 02 143-42	sleeve	1	60
25	90 14 20 026 00 90	seal	1	2
26	04 28 22 009 20-42	connection	2	60
27	09 14 10 081 90	seal	2	2
28	09 24 03 094-07	nipple	2	30
29	04 23 10 023 00 90	fixing set	6	2
30	09 30 11 130-07	connection	2	30
31	09 24 03 081 10 90	extension	4	2
32	09 24 03 080 90	extension	2	2