

Hand shower set for bath rim or tile edge installation - Brushed Champagne (22kt Gold)

IMO

27 702 980









Fits: IMO, MEM, CL.1, CYO

- COMPACT RAIN, max. flow rate 6.8 l/min (at 3 bar)
- with anti-scale system
- rosette 60 x 60 mm
- hole diameter 32 mm
- metal shower hose 2250mm with integrated anti-twist protection

Two-piece design allows hose to later be changed without dismantling the fitting.

Intrinsic protection against back flow.

	Brushed Champagne (22kt Gold)	27 702 980-46
	Chrome	27 702 980-00
	Brushed Platinum	27 702 980-06
	Platinum	27 702 980-08
	Dark Chrome	27 702 980-19
	Brushed Light Gold	27 702 980-27
	Brushed Durabrass (23kt Gold)	27 702 980-28
	Matte Black	27 702 980-33
	Champagne (22kt Gold)	27 702 980-47
	Brushed Chrome	27 702 980-93
	Brushed Dark Platinum	27 702 980-99

27 702 980

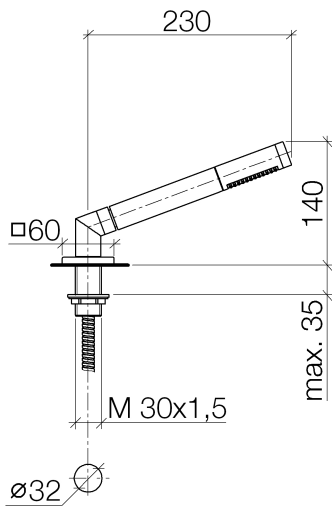

Flow rate chart

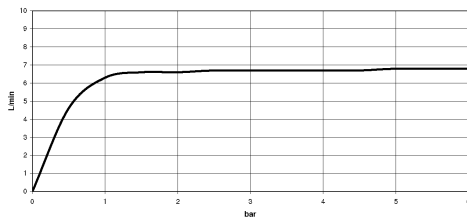

Certificates

Belgaqua_21-383- WRAS_2209005.
27_8.

**Hand shower set for bath rim or tile edge installation - Brushed Champagne
(22kt Gold)**

IMO

27 702 980

Parts for other
finishes can be found
here: [Chrome](#)

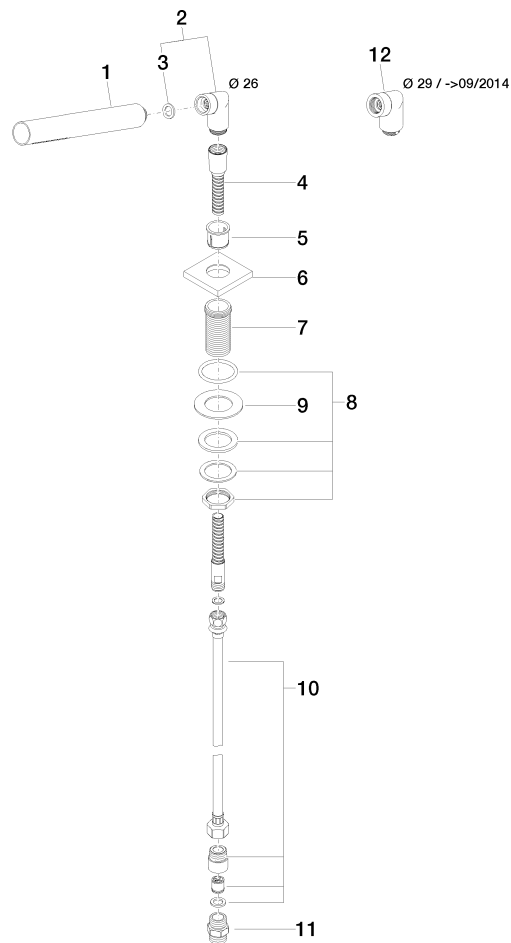

Spare parts list

No.	Item Number	Name	Quantity used	Delivery time
1	90 12 11 140 30-46	shower	1	30
2	04 24 04 287 00-46	nipple	1	30
3	90 14 20 002 00 90	seal	1	2
4	28 322 970-46	Metal shower hose 1/2" x 3/8" x 1750 mm - Brushed Champagne (22kt Gold)	1	30
5	90 18 40 085 00 90	sleeve	1	2
6	09 27 68 003-46	rosette	1	30
7	09 30 01 090-07	sleeve	1	30
8	04 23 10 032 46 90	fixing set	1	2
9	09 30 11 060 90	disc	1	2
10	12 505 970 90	High pressure hose 1/2" x 3/8" x 500 mm -	1	2
11	90 24 03 168 00 90	nipple	1	2
12	04 24 04 187 00-46	nipple	1	-

Spare part can no longer be ordered, please order the replacement item