













27 808 980



Fits: IMO, MEM, CL.1, CYO

- COMPACT RAIN, max. flow rate 15 l/min (at 3 bar)
- with anti-scale system
- 3/8" shower outlet
- rosette for wall elbow 60 x 60mm
- rosette for shower holder 60 x 60mm
- metal shower hose 1250mm with integrated anti-twist protection
- 1/2" wall elbow

Intrinsic protection against back flow.

	Brushed Durabrass (23kt Gold)	27 808 980-28
	Chrome	27 808 980-00
	Chrome	27 808 980-00 0010
	Brushed Platinum	27 808 980-06
	Brushed Platinum	27 808 980-06 0010
	Platinum	27 808 980-08
	Platinum	27 808 980-08 0010
	Dark Chrome	27 808 980-19
	Dark Chrome	27 808 980-19 0010
	Brushed Light Gold	27 808 980-27
	Brushed Light Gold	27 808 980-27 0010
	Brushed Durabrass (23kt Gold)	27 808 980-28 0010
	Matte Black	27 808 980-33
	Matte Black	27 808 980-33 0010
	Brushed Champagne (22kt Gold)	27 808 980-46 0010
	Champagne (22kt Gold)	27 808 980-47 0010
	Brushed Chrome	27 808 980-93
	Brushed Chrome	27 808 980-93 0010
	Brushed Dark Platinum	27 808 980-99
	Brushed Dark Platinum	27 808 980-99 0010

Recommended miscellaneous

- Concealed wall elbow -** 35 085 970 90
- max. recess depth 163 mm
 - min. recess depth 90 mm





Hand shower set with individual rosettes - Brushed Durabrass (23kt Gold)

IMO

27 808 980

27 808 980

mm [inches]

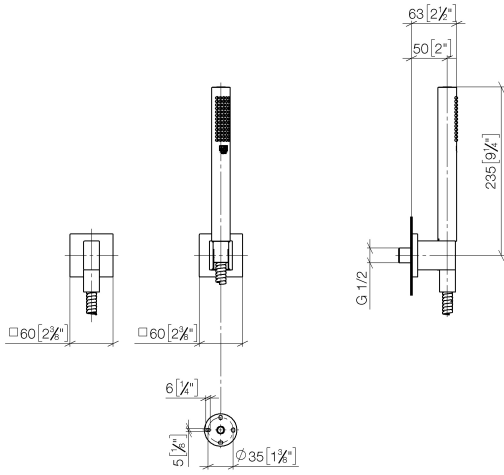

Flow rate chart



Certificates

LGA_29985. Belgaqua_22_280_2 WRAS_2209005.
7_7.

27 808 980

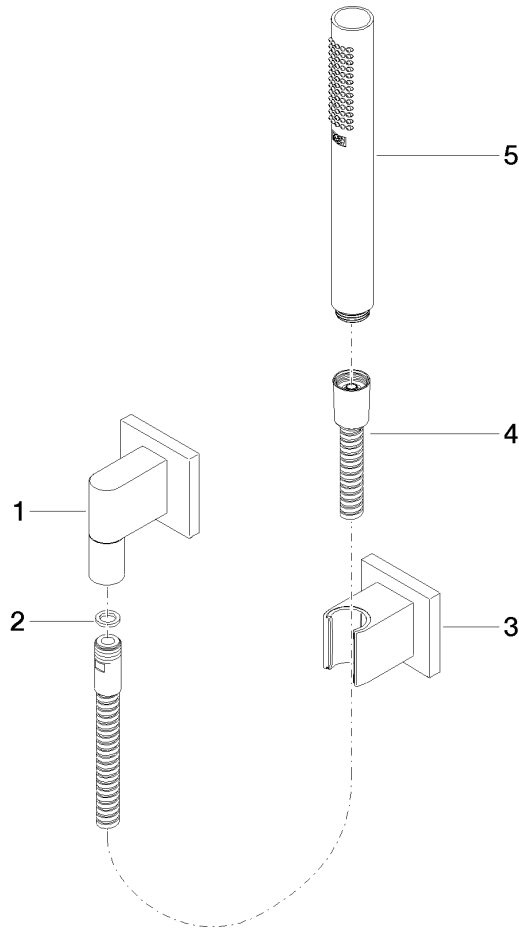

Spare parts list

No.	Item Number	Name	Quantity used	Delivery time
1	28 450 980-28	Wall elbow - Brushed Durabron (23kt Gold)	1	20
2	90 14 20 026 00 90	seal	1	2
3	28 050 980-28	Wall bracket - Brushed Durabron (23kt Gold)	1	20
4	90 30 02 072 00-28	Metal shower hose 1/2" x 3/8" x 1250 mm - Brushed Durabron (23kt Gold)	1	20
5	90 12 11 152 00-28	shower	1	-

Spare part can no longer be ordered, please order the replacement item