

## Affusion pipe with cover plate - Brushed Dark Platinum

IMO









27 838 979



Fits: IMO, MEM, CL.1, CYO

- LAMINAR FLOW, max. flow rate 15 l/min (at 3 bar)
- 3/8" shower outlet
- cover plate 240 x 60 mm
- metal shower hose 1250mm with integrated anti-twist protection
- 1/2" connection
- plug-link mounting

Intrinsic protection against back flow.

	Brushed Dark Platinum	27 838 979-99
	Chrome	27 838 979-00
	Brushed Platinum	27 838 979-06
	Platinum	27 838 979-08
	Dark Chrome	27 838 979-19
	Brushed Light Gold	27 838 979-27
	Brushed Durabronze (23kt Gold)	27 838 979-28
	Matte Black	27 838 979-33
	Brushed Chrome	27 838 979-93

### Recommended miscellaneous



**Concealed wall elbow -**

- max. recess depth 163 mm
- min. recess depth 90 mm

35 085 970 90

27 838 979

mm [inches]



Flow rate chart



Certificates

Belgaqua\_21-023- LGA\_38675.  
27\_8.

27 838 979

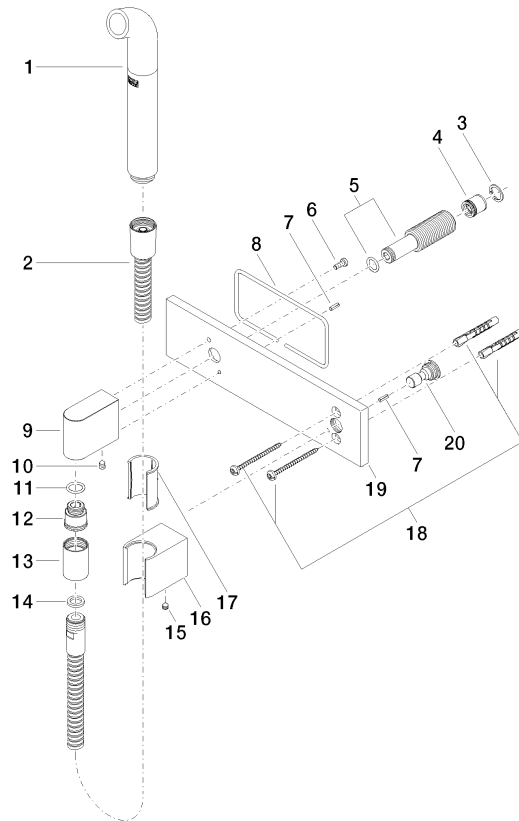

### Spare parts list

No.	Item Number	Name	Quantity used	Delivery time
1	04 12 11 073 01-99	spout	1	30
2	90 30 02 072 00-99	Metal shower hose 1/2" x 3/8" x 1250 mm - Brushed Dark Platinum	1	30
3	09 16 01 014 90	ring	1	2
4	09 23 01 046 90	back-flow preventer	1	2
5	90 24 03 212 00 90	nipple	1	2
6	09 14 10 008 90	seal	1	2
7	09 31 11 026 90	pin	2	2
8	09 14 03 127 90	seal	1	2
9	09 11 03 046-99	connection	1	30
10	90 31 11 004 00 90	pin	1	2
11	90 14 10 077 00 90	seal	1	2
12	09 24 03 107 20 90	nipple	1	2
13	90 21 02 069 00-99	cover	1	30
14	90 14 20 026 00 90	seal	1	2
15	90 31 11 112 00 90	pin	1	2
16	09 17 20 044-99	holder	1	30
17	09 18 40 078 90	sleeve	1	2
18	05 30 31 025 00 90	fixing set	1	2
19	09 11 02 133-99	plate	1	30
20	09 24 03 073 90	nipple	1	2