













28 678 970



- 450mm projection
- rain shower Ø 300 mm
- PURE RAIN, max. flow rate 9 l/min (at 3 bar)
- Function from: 7 l/min
- rosette Ø 60 mm
- 1/2" connection
- with anti-scale system
- quick clearing
- WRAS
- This product can help a building meet the requirements of Green Building Rating Systems, e.g. LEED®, BREEAM®, DGNB

Fits: TARA, LISSÉ, VAIA, META

	Champagne (22kt Gold)	28 678 970-47
	Chrome	28 678 970-00
	Brushed Platinum	28 678 970-06
	Platinum	28 678 970-08
	Dark Chrome	28 678 970-19
	Light Gold	28 678 970-26
	Brushed Light Gold	28 678 970-27
	Brushed Durabronze (23kt Gold)	28 678 970-28
	Matte Black	28 678 970-33
	Brushed Bronze	28 678 970-42
	Brushed Champagne (22kt Gold)	28 678 970-46
	Brushed Chrome	28 678 970-93
	Brushed Dark Platinum	28 678 970-99

28 678 970

mm [inches]

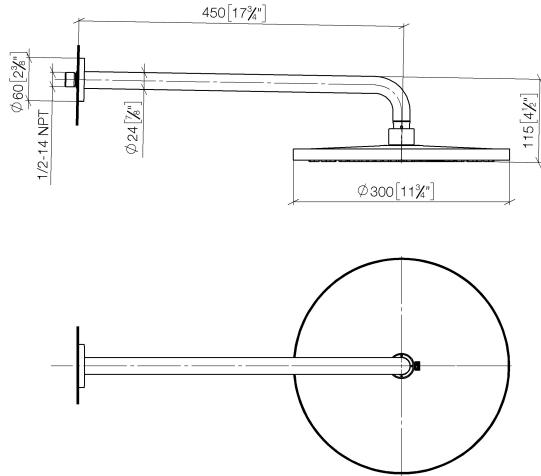

Flow rate chart



Certificates

LGA\_29235.

28 678 970

Parts for other finishes can be found here: [Chrome](#)

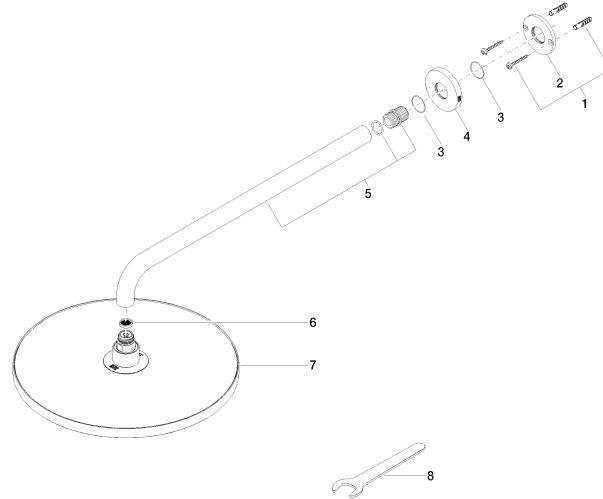

### Spare parts list

No.	Item Number	Name	Quantity used	Delivery time
1	04 30 31 032 00 90	fixing set	1	2
2	09 17 20 120 90	holder	1	2
3	09 14 10 150 90	seal	2	2
4	09 27 97 015-47	rosette	1	30
5	90 11 03 070 00-47	pipe	1	30
6	09 23 01 075 90	insert	1	2
7	90 12 05 091 20-47	shower	1	30
8	90 30 09 069 00 90	key	1	2