

Rain shower with wall fixing 300 x 240 mm - Brushed Platinum

IMO









28 765 980



- 450mm projection
- rain shower 300 x 240mm
- PURE RAIN, max. flow rate 20 l/min (at 3 bar)
- Function from: 12 l/min
- rosette 60 x 60 mm
- 1/2" connection
- with anti-scale system
- quick clearing
- WRAS 1707033

Fits: IMO, MEM, CL.1

Product change as of 1st April 2024: max. flow 20l/min

	Brushed Platinum	28 765 980-06
	Chrome	28 765 980-00
	Platinum	28 765 980-08
	Brushed Light Gold	28 765 980-27
	Brushed Durabronze (23kt Gold)	28 765 980-28
	Matte Black	28 765 980-33
	Brushed Chrome	28 765 980-93
	Brushed Dark Platinum	28 765 980-99

Recommended miscellaneous



- Concealed wall elbow -** 35 085 970 90
- max. recess depth 163 mm
 - min. recess depth 90 mm

28 765 980

mm [inches]

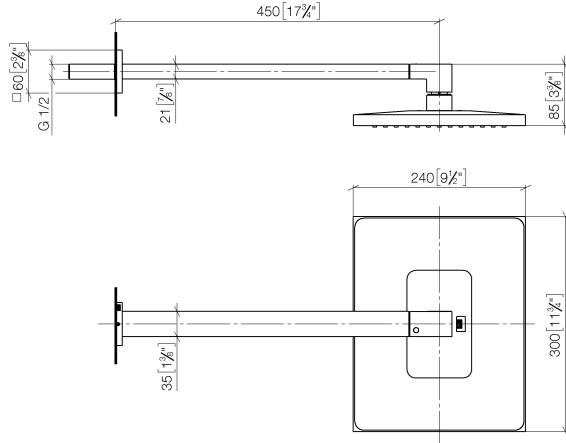

Flow rate chart

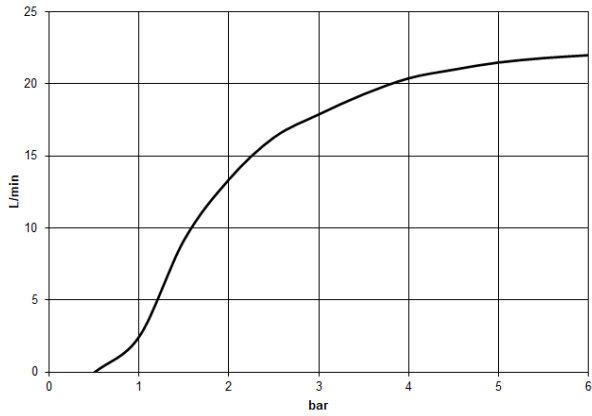

Certificates

LGA_29229. WRAS_2212012. LGA_38662.

28 765 980

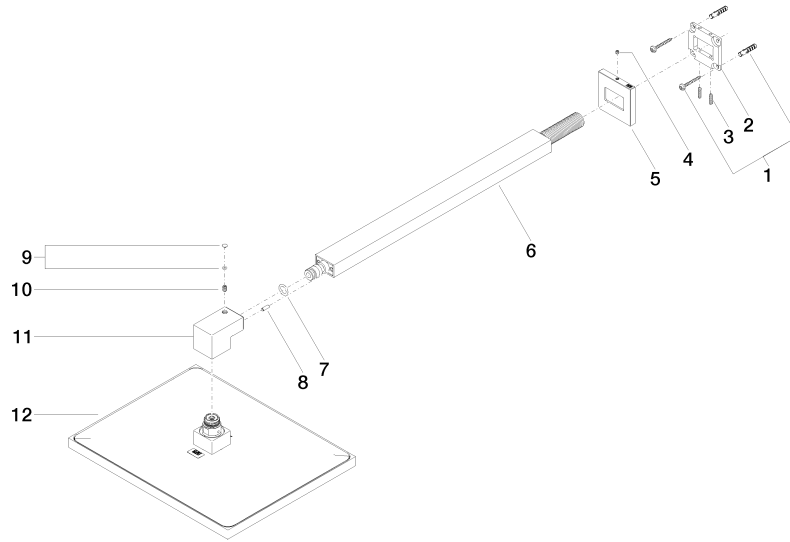

Spare parts list

No.	Item Number	Name	Quantity used	Delivery time
1	04 30 31 032 00 90	fixing set	1	2
2	09 30 11 160 90	disc	1	2
3	09 31 11 084 90	pin	2	2
4	09 31 11 099 90	pin	1	2
5	09 27 98 016-06	rosette	1	10
6	04 28 22 247 20-06	pipe	1	10
7	90 14 10 011 00 90	seal	1	2
8	09 31 11 040 90	pin	1	2
9	90 31 20 087 00-06	plug	1	10
10	09 31 11 036 90	pin	1	2
11	09 17 01 180-06	connection	1	10
12	04 12 05 063 00-06	shower	1	10