









LOT Two-hole mixer with cover plate - Brushed Durabron (23kt Gold)

LOT

32 843 680



- 235mm projection
- pivotable spout 360°
- air-enriched flow
- height of mixer 345 mm
- height up to aerator 319 mm
- cover plate 126 x 55 mm
- hole diameter spout 35 mm
- single-lever mixer hole diameter 44 mm
- gauge 71 mm
- max. flow 8 l/min at 3 bar flow pressure
- lead-free
- WRAS 1909073
- This product can help a building meet the requirements of Green Building Rating Systems, e.g. LEED®, BREEAM®, DGNB

	Brushed Durabron (23kt Gold)	32 843 680-28
	Chrome	32 843 680-00
	Brushed Platinum	32 843 680-06
	Platinum	32 843 680-08
	Dark Chrome	32 843 680-19
	Brushed Champagne (22kt Gold)	32 843 680-46
	Champagne (22kt Gold)	32 843 680-47
	Brushed Dark Platinum	32 843 680-99

Recommended miscellaneous

Strainer waste with control handle - Brushed Durabron (23kt Gold) 10 711 970-28



Recommended miscellaneous

Dispenser with rosette - Brushed Durabron (23kt Gold) 82 439 970-28



32 843 680

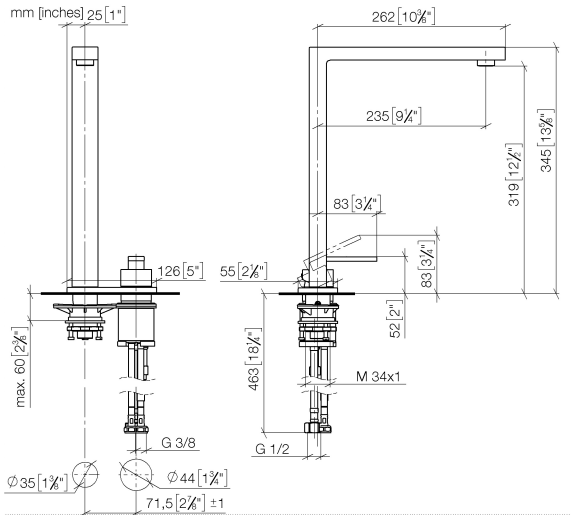

Flow rate chart

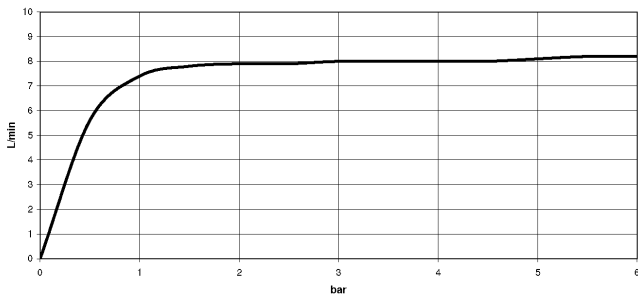

Codes & Standards

DIN 4109	EN 817	Executive Order no. 1007	ISO 3822
Scottish Water Byelaws	UK Water Supply Regulations	Ü-Zeichen	VA-Zeichen



LOT Two-hole mixer with cover plate - Brushed Durabronz (23kt Gold)

LOT

32 843 680

Certificates

LGA_18

WRAS_1909

GDV_0400

ETA_18

32 843 680

Product version from 5/31/2010 to 3/10/2021

Product version from 3/10/2021 to 5/10/2021

Product version from 5/10/2021

Product version from 6/1/2022

Parts for other finishes can be found here: [Chrome](#)

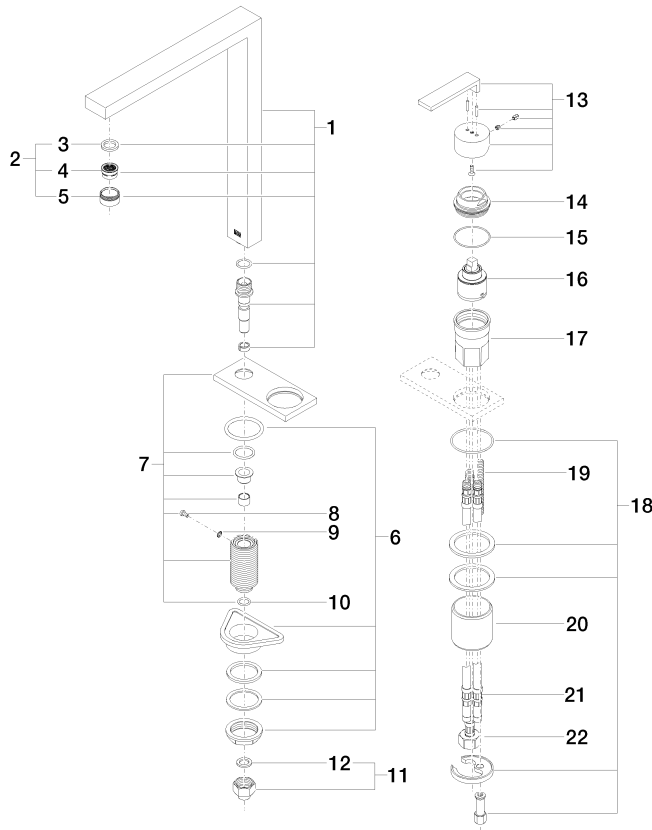



LOT Two-hole mixer with cover plate - Brushed Durabronz (23kt Gold)

LOT

32 843 680

Spare parts list

Product version from 5/31/2010 to 3/10/2021

Product version from 3/10/2021 to 5/10/2021

Product version from 5/10/2021

Product version from 6/1/2022