

TARA Single-lever mixer - Dark Chrome

TARA

33 815 888



- 236mm projection
- pivotable spout 360°
- air-enriched flow
- height of mixer 400 mm
- height up to aerator 230 mm
- hole diameter 35 mm
- max. flow 7 l/min at 3 bar flow pressure
- lead-free
- WRAS 1705020
- This product can help a building meet the requirements of Green Building Rating Systems, e.g. LEED®, BREEAM®, DGNB

	Dark Chrome	33 815 888-19
	Chrome	33 815 888-00
	Brushed Platinum	33 815 888-06
	Platinum	33 815 888-08
	Durabrand (23kt Gold)	33 815 888-09
	Brushed Durabrand (23kt Gold)	33 815 888-28
	Matte Black	33 815 888-33
	Brushed Champagne (22kt Gold)	33 815 888-46
	Champagne (22kt Gold)	33 815 888-47
	Brushed Chrome	33 815 888-93
	Brushed Dark Platinum	33 815 888-99

Recommended miscellaneous

Dispenser with rosette - Dark Chrome 82 444 970-19



Recommended miscellaneous

Strainer waste with control handle - Dark Chrome 10 710 970-19



33 815 888

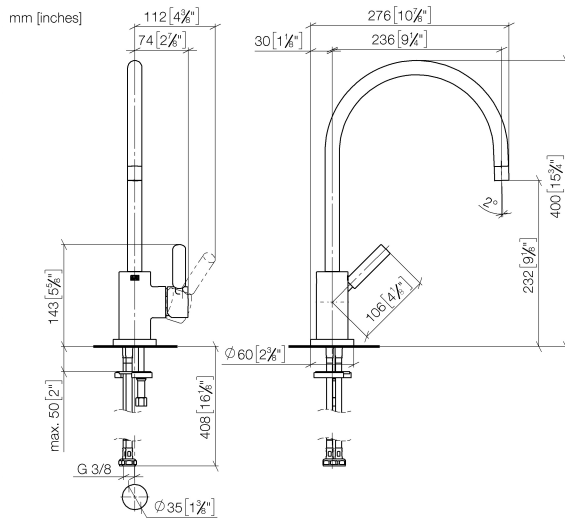

Flow rate chart



Certificates

GDV_0400195.

WRAS_2311044.

33 815 888

Parts for other finishes can be found here: [Chrome](#)

