





33 816 875



- 241mm projection
- pivotable spout 360°
- air-enriched flow
- height of mixer 393 mm
- height up to aerator 240 mm
- hole diameter 35 mm
- max. flow 8 l/min at 3 bar flow pressure
- lead-free
- This product can help a building meet the requirements of Green Building Rating Systems, e.g. LEED®, BREEAM®, DGNB
- WRAS 2101012

	Durabron (23kt Gold)	33 816 875-09
	Chrome	33 816 875-00
	Brushed Platinum	33 816 875-06
	Platinum	33 816 875-08
	Dark Chrome	33 816 875-19
	Brushed Durabron (23kt Gold)	33 816 875-28
	Matte Black	33 816 875-33
	Brushed Champagne (22kt Gold)	33 816 875-46
	Champagne (22kt Gold)	33 816 875-47
	Brushed Chrome	33 816 875-93
	Brushed Dark Platinum	33 816 875-99

**Recommended miscellaneous**

**Dispenser without rosette - Durabron (23kt Gold)** 82 424 970-09



**Recommended miscellaneous**

**Strainer waste with control handle - Durabron (23kt Gold)** 10 712 970-09



33 816 875

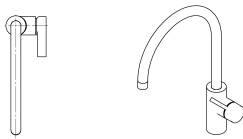
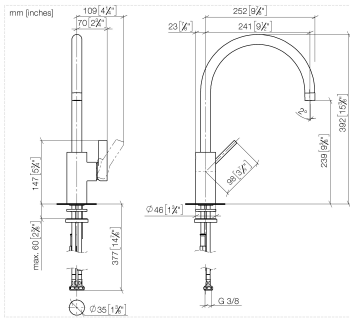

Flow rate chart

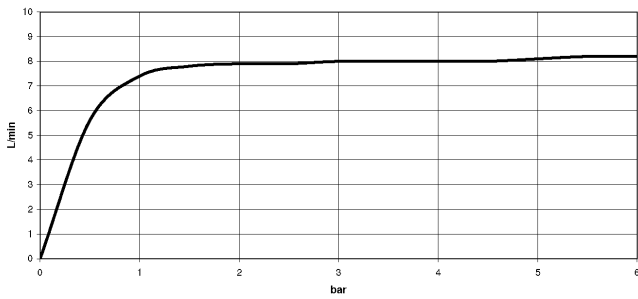

Codes & Standards

DIN 4109

Executive Order  
no. 1007

ISO 3822

Ü-Zeichen



TARA ULTRA Single-lever mixer - Durabronz (23kt Gold)

TARA ULTRA

33 816 875

Certificates

GDV\_0400

LGA\_18

33 816 875

**Product version from 6/1/2022**

Parts for other finishes can be found here: [Chrome](#)

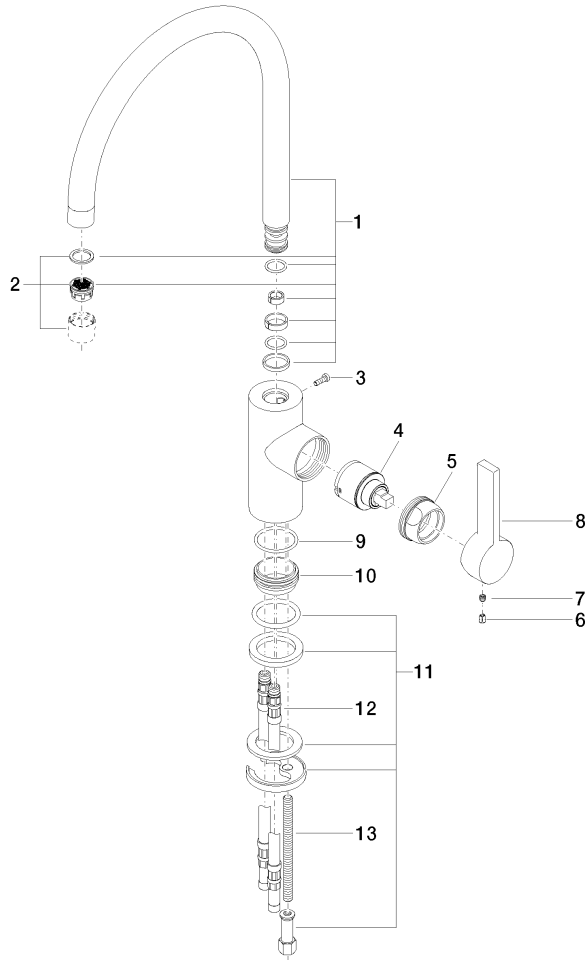



33 816 875

## **Spare parts list**

**Product version from 6/1/2022**