







33 860 875



- 240mm projection
- pivotable 360°
- air-enriched flow and spray flow
- height of mixer 685 mm
- height up to aerator 129 mm
- hole diameter 35 mm
- sprayface with anti-scaling system
- max. flow 8 l/min at 3 bar flow pressure
- lead-free
- This product can help a building meet the requirements of Green Building Rating Systems, e.g. LEED®, BREEAM®, DGNB

Intrinsic protection against back flow.

	Brushed Dark Platinum	33 860 875-99
	Chrome	33 860 875-00
	Brushed Platinum	33 860 875-06
	Platinum	33 860 875-08
	Dark Chrome	33 860 875-19
	Brushed Chrome	33 860 875-93

Recommended miscellaneous

**Dispenser without rosette -  
Brushed Dark Platinum**

82 424 970-99



Recommended miscellaneous

**Strainer waste with control handle -  
Brushed Dark Platinum**

10 712 970-99



33 860 875

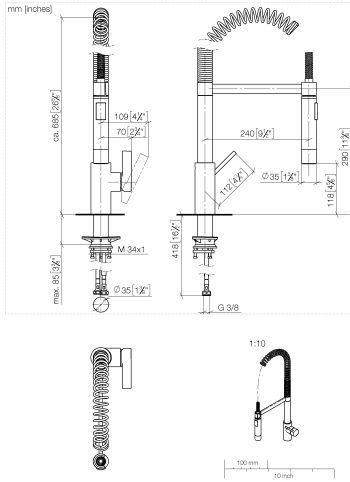

Flow rate chart

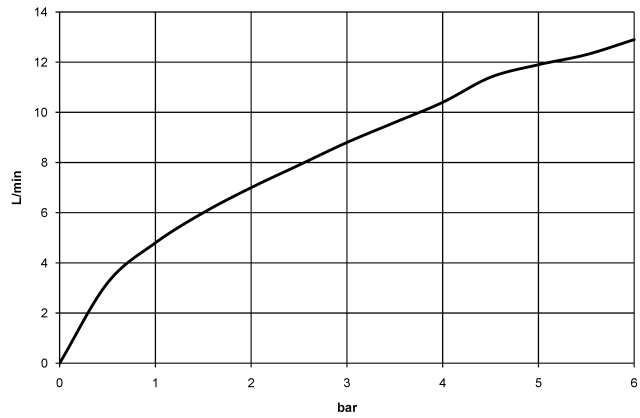

Certificates

Belgaqua\_22\_277\_2  
7\_3.

33 860 875

Parts for other finishes can be found here: [Chrome](#)

