

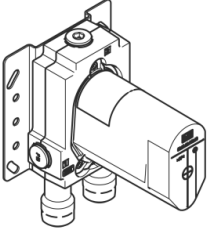

EDITION PRO Concealed single-lever mixer with backflow preventor -

35 071 970 90

- WRAS 2207012



Recommended miscellaneous

Extension 25 mm -

12 190 970 90



Recommended miscellaneous

Extension 25 mm -

12 191 970 90





EDITION PRO Concealed single-lever mixer with backflow preventor -

35 071 970 90

mm [inches]

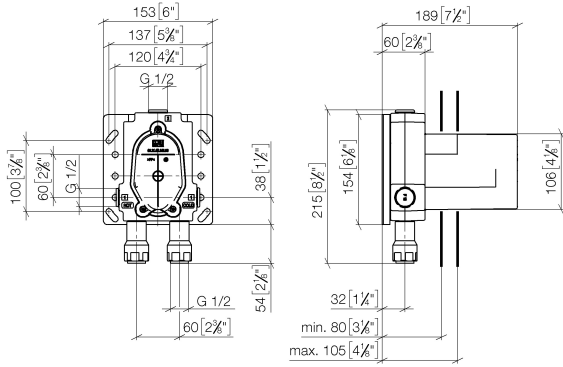

Codes & Standards

DIN 4109

ISO 3822

Scottish Water
Byelaws

UK Water Supply
Regulations

Ü-Zeichen

Certificates

WRAS_2207

LGA_19

LGA_19

EDITION PRO Concealed single-lever mixer with backflow preventor -

35 071 970 90

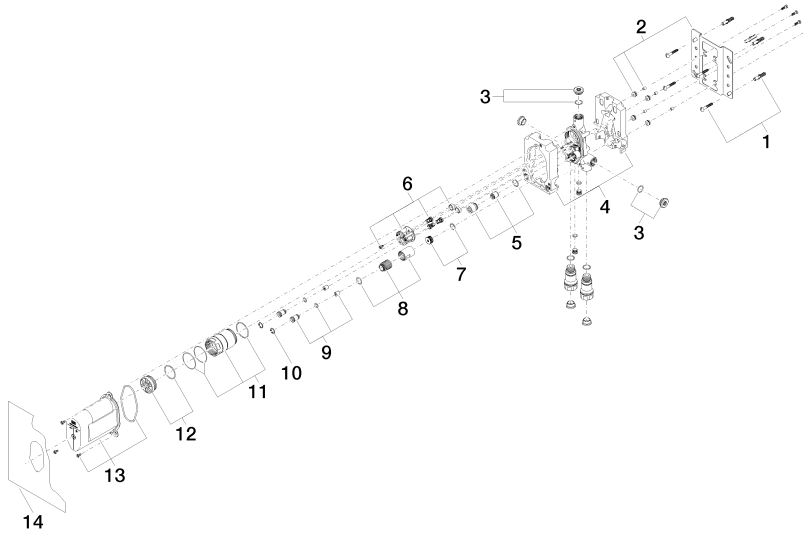



EDITION PRO Concealed single-lever mixer with backflow preventor -

35 071 970 90

Spare parts list

No.	Item Number	Name	Quantity used	Delivery time
	04 30 31 024 01 90	fixing set	18	2