

Concealed single-lever mixer with cover plate - Brushed Chrome











IMO

36 060 670



- cover plate 80 x 80 mm
- WRAS 2107016

Fits: IMO, MEM, CL.1, CYO

	Brushed Chrome	36 060 670-93
	Chrome	36 060 670-00
	Brushed Platinum	36 060 670-06
	Platinum	36 060 670-08
	Dark Chrome	36 060 670-19
	Brushed Light Gold	36 060 670-27
	Brushed Durabronze (23kt Gold)	36 060 670-28
	Matte Black	36 060 670-33
	Brushed Champagne (22kt Gold)	36 060 670-46
	Champagne (22kt Gold)	36 060 670-47
	Brushed Dark Platinum	36 060 670-99

Required miscellaneous



Concealed wall-mounted single-lever mixer - 35 860 970 90

- max. recess depth 95 mm
- min. recess depth 75 mm

36 060 670

mm [inches]



Certificates

WRAS_2107016. LGA_29905.

36 060 670

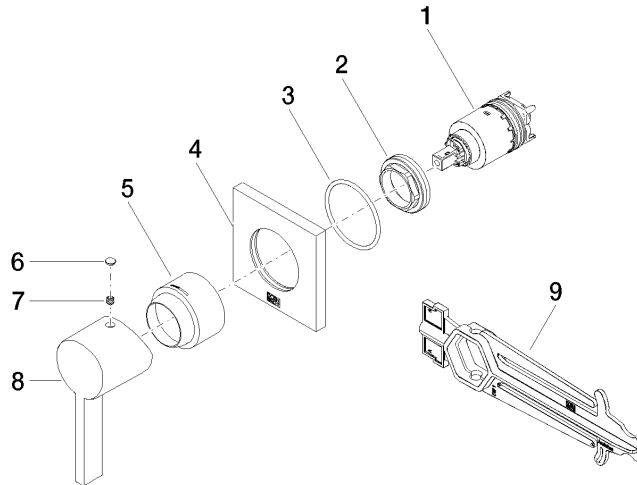

Spare parts list

No.	Item Number	Name	Quantity used	Delivery time
1	90 15 05 064 01 90	cartridge	1	2
2	09 24 04 105 90	nut	1	2
3	90 14 10 049 00 90	seal	1	2
4	09 27 78 048-93	rosette	1	20
5	09 11 02 530-93	cover	1	20
6	90 31 20 087 00-93	plug	1	20
7	90 31 11 112 00 90	pin	1	2
8	09 20 67 004-93	handle	1	20
9	90 30 09 064 00 90	key	1	2