

**Concealed single-lever mixer with diverter - Brushed Chrome**













TARA

36 120 660

- automatic diverter
- cover plate Ø 150 mm



Fits: TARA, META

	Brushed Chrome	36 120 660-93
	Chrome	36 120 660-00
	Brushed Platinum	36 120 660-06
	Platinum	36 120 660-08
	Dark Chrome	36 120 660-19
	Light Gold	36 120 660-26
	Brushed Light Gold	36 120 660-27
	Brushed Durabronze (23kt Gold)	36 120 660-28
	Matte Black	36 120 660-33
	Brushed Bronze	36 120 660-42
	Brushed Champagne (22kt Gold)	36 120 660-46
	Champagne (22kt Gold)	36 120 660-47
	Brushed Dark Platinum	36 120 660-99

36 120 660

mm [inches]

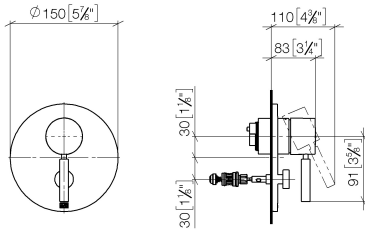

Flow rate chart

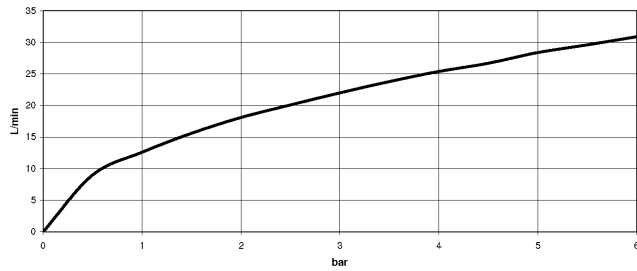

Certificates

DVGW\_DW-  
6512DN0126.

LGA\_19863.

WRAS\_2207012.

36 120 660

Parts for other finishes can be found here: [Chrome](#)

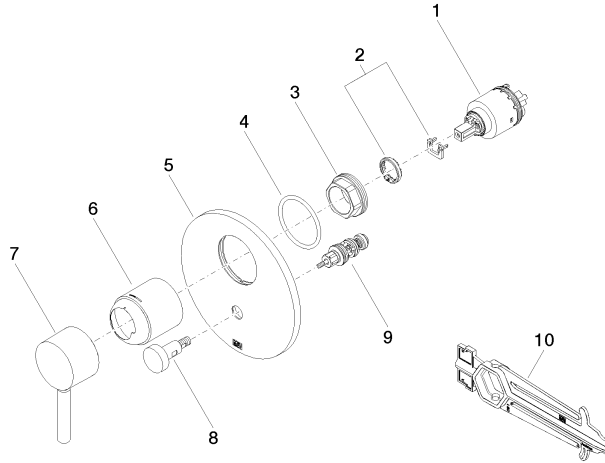

### Spare parts list

No.	Item Number	Name	Quantity used	Delivery time
1	90 15 05 038 00 90	cartridge	1	60
2	04 28 10 149 00 90	accessories	1	2
3	09 24 04 448 90	nut	1	2
4	09 14 10 084 90	seal	1	2
5	09 11 02 261-93	plate	1	20
6	09 11 02 260-93	sleeve	1	20
7	90 20 66 004 00-93	handle	1	20
8	90 31 09 139 00-93	pull-rod	1	20
9	90 21 34 081 00 90	diverter	1	2
10	90 30 09 064 00 90	key	1	2