







SYMETRICS Concealed two-way diverter - Chrome

IMO

36 200 985



- rotary diverter
- rosette 60 x 60 mm
- WRAS 2307045

	Chrome	36 200 985-00
	Brushed Platinum	36 200 985-06
	Brushed Light Gold	36 200 985-27
	Brushed Durabronze (23kt Gold)	36 200 985-28
	Brushed Champagne (22kt Gold)	36 200 985-46
	Champagne (22kt Gold)	36 200 985-47
	Brushed Dark Platinum	36 200 985-99

Required miscellaneous



- Concealed two-way diverter -** 35 202 970 90
- max. recess depth 160 mm
 - min. recess depth 85 mm

36 200 985

mm [inches]

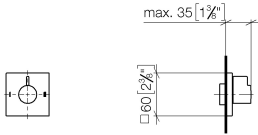

Flow rate chart

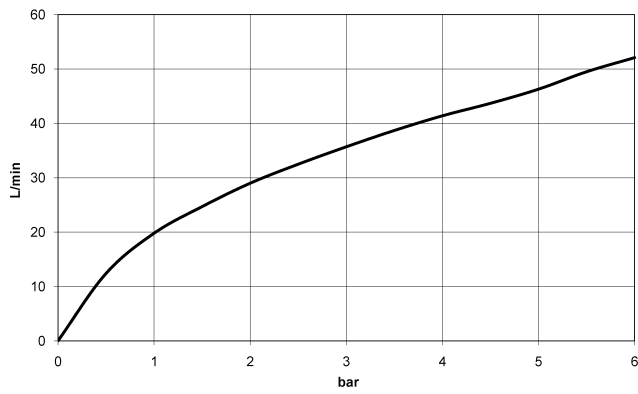

Codes & Standards

DIN 4109

ISO 3822

Scottish Water
Byelaws

UK Water Supply
Regulations

Ü-Zeichen



SYMETRICS Concealed two-way diverter - Chrome

IMO

36 200 985

Certificates

WRAS_2307

LGA_38

36 200 985

Product version from 4/1/2022

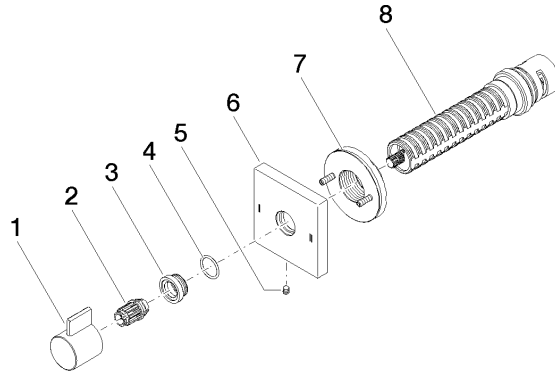



SYMETRICS Concealed two-way diverter - Chrome

IMO

36 200 985

Spare parts list

Product version from 4/1/2022

No.	Item Number	Name	Quantity used	Delivery time
	09 20 98 002-00	handle	8	10