













36 517 979



- HORIZONTAL RAIN, max. flow rate 6 l/min (at 3 bar)
- with anti-scale system
- cover plate 240 x 60 mm
- 1/2" connection
- This product can help a building meet the requirements of Green Building Rating Systems, e.g. LEED®, BREEAM®, DGNB
- WRAS 1304001

Fits: IMO, LULU, MADISON, MEM, TARA, CL.1, LISSÉ, VAIA, META, CYO

	Brushed Chrome	36 517 979-93
	Chrome	36 517 979-00
	Brushed Platinum	36 517 979-06
	Platinum	36 517 979-08
	Dark Chrome	36 517 979-19
	Light Gold	36 517 979-26
	Brushed Light Gold	36 517 979-27
	Brushed Durabronze (23kt Gold)	36 517 979-28
	Matte Black	36 517 979-33
	Brushed Bronze	36 517 979-42
	Brushed Champagne (22kt Gold)	36 517 979-46
	Champagne (22kt Gold)	36 517 979-47
	Brushed Dark Platinum	36 517 979-99

36 517 979

mm [inches]

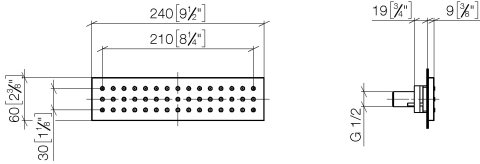

Flow rate chart

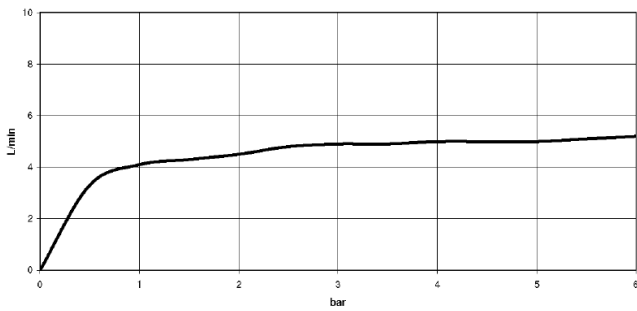

Trajectory diagram

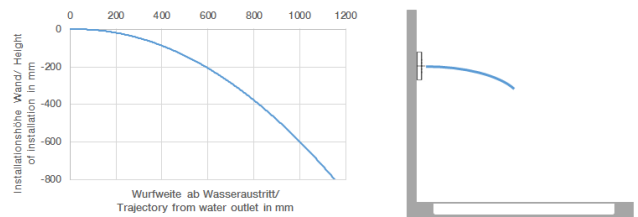

Codes & Standards

DIN 4109

ISO 3822

Scottish Water
Byelaws

UK Water Supply
Regulations

Ü-Zeichen



WATER BAR Concealed body spray FlowReduce - Brushed Chrome

IMO

36 517 979

Certificates

LGA_19

WRAS_1304

36 517 979

Product version up to 5/15/2020

Product version from 5/15/2020 to 5/16/2020

Product version from 5/16/2020

Parts for other
finishes can be found
here: [Chrome](#)

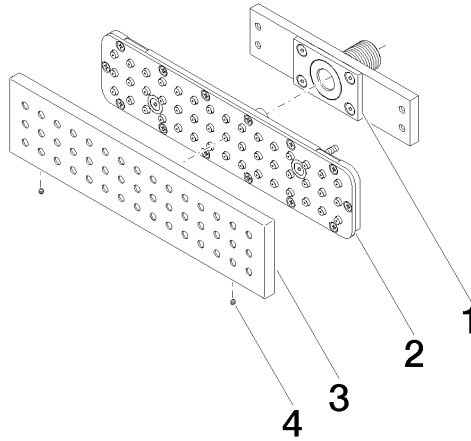



WATER BAR Concealed body spray FlowReduce - Brushed Chrome

IMO

36 517 979

Spare parts list

Product version up to 5/15/2020

Product version from 5/15/2020 to 5/16/2020

Product version from 5/16/2020

No.	Item Number	Name	Quantity used	Delivery time
	90 11 02 137 00 90	connection	4	2