

**WATER BAR Concealed body spray - Brushed Dark Platinum**

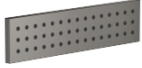











IMO

36 527 979



- HORIZONTAL RAIN, max. flow rate 9 l/min (at 3 bar)
- with anti-scale system
- cover plate 240 x 60 mm
- 1/2" connection

Fits: IMO, LULU, MADISON, MEM, TARA, CL.1, LISSÉ, VAIA, META, CYO

|  |                                |               |
|--|--------------------------------|---------------|
|    | Brushed Dark Platinum          | 36 527 979-99 |
|    | Chrome                         | 36 527 979-00 |
|    | Brushed Platinum               | 36 527 979-06 |
|    | Platinum                       | 36 527 979-08 |
|    | Dark Chrome                    | 36 527 979-19 |
|    | Light Gold                     | 36 527 979-26 |
|    | Brushed Light Gold             | 36 527 979-27 |
|    | Brushed Durabronze (23kt Gold) | 36 527 979-28 |
|   | Matte Black                    | 36 527 979-33 |
|  | Brushed Bronze                 | 36 527 979-42 |
|  | Brushed Champagne (22kt Gold)  | 36 527 979-46 |
|  | Champagne (22kt Gold)          | 36 527 979-47 |
|  | Brushed Chrome                 | 36 527 979-93 |

**Required miscellaneous**



**Concealed wall installation box -** 35 206 970 90  
 ● max. recess depth 173 mm  
 ● min. recess depth 100 mm

**Recommended miscellaneous**



**xGRID Attachment set for integrating in the dry wall construction -** 12 340 970 90

**Required miscellaneous**



**xGRID Installation track 555 mm -** 12 360 970 90

36 527 979

mm [inches]

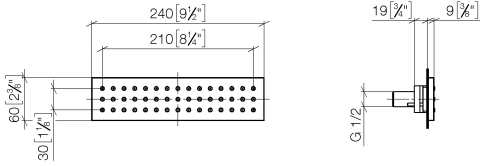

**Flow rate chart**

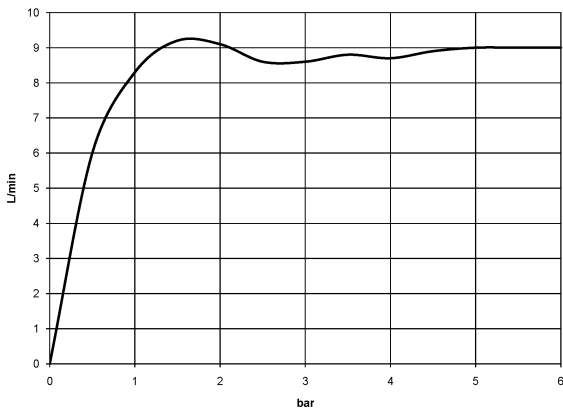

**Codes & Standards**

DIN 4109

ISO 3822

Ü-Zeichen



## WATER BAR Concealed body spray - Brushed Dark Platinum

---

IMO

36 527 979

Certificates

---

LGA\_38

36 527 979

Product version from 10/1/2023

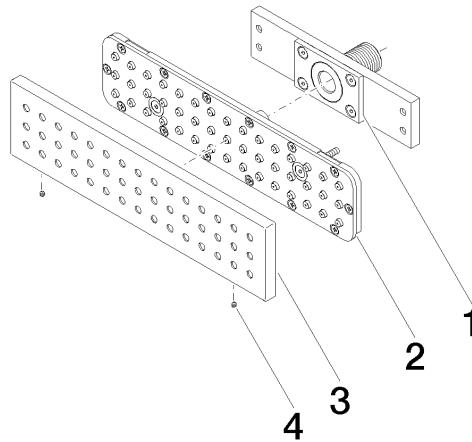



# WATER BAR Concealed body spray - Brushed Dark Platinum

IMO

36 527 979

## Spare parts list

### Product version from 10/1/2023

| No. | Item Number        | Name       | Quantity used | Delivery time |
|-----|--------------------|------------|---------------|---------------|
|     | 90 11 02 137 00 90 | connection | 5             | 2             |