







SYMETRICS Wall valve anti-clockwise closing 3/4" - Brushed Platinum

IMO

36 608 985

- rosette 60 x 60 mm
- head part with cut-to-length spindle and sleeve



	Brushed Platinum	36 608 985-06
	Chrome	36 608 985-00
	Platinum	36 608 985-08
	Brushed Light Gold	36 608 985-27
	Brushed Durabronze (23kt Gold)	36 608 985-28
	Brushed Dark Platinum	36 608 985-99

Required miscellaneous



- Wall valve 3/4" -** 35 608 970 90
- max. recess depth 145 mm
 - min. recess depth 75 mm

36 608 985

mm [inches]

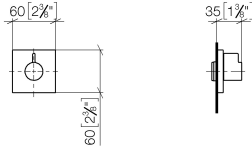

Certificates

IAPMO_4976 (1). WRAS_2010066.

36 608 985

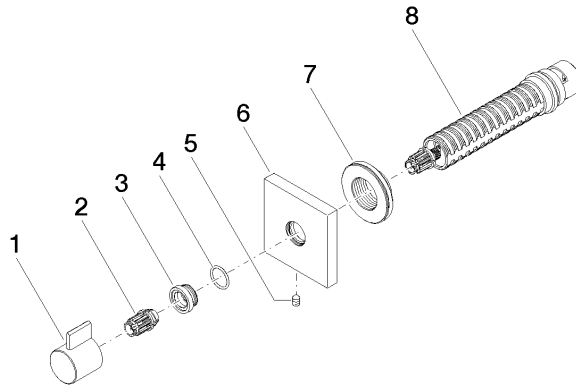

Spare parts list

No.	Item Number	Name	Quantity used	Delivery time
1	09 20 98 002-06	handle	1	10
2	09 12 12 005 90	fixing cap	1	2
3	09 12 12 043-06	base	1	10
4	09 14 10 017 90	seal	1	2
5	90 31 11 004 00 90	pin	1	2
6	09 27 98 014-06	rosette	1	10
7	09 21 02 151 90	sleeve	1	2
8	90 90 03 128 00 90	top	1	2