







**CL.1 Wall valve clockwise closing cold 1/2" - Brushed Platinum**

CL.1

36 627 706



- with CASCADE structure
- rosette 60 x 60 mm
- with cold marking
- head part with cut-to-length spindle and sleeve

	Brushed Platinum	36 627 706-06
	Chrome	36 627 706-00
	Dark Chrome	36 627 706-19
	Brushed Champagne (22kt Gold)	36 627 706-46
	Champagne (22kt Gold)	36 627 706-47
	Brushed Dark Platinum	36 627 706-99

**Required miscellaneous**



- Wall valve 1/2" -** 35 607 970 90
- max. recess depth 150 mm
  - min. recess depth 105 mm

36 627 706

mm [inches]

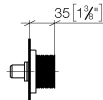
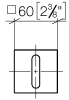

Certificates

DVGW\_DW-  
6501DN0116.

IAPMO\_4976 (1).

LGA\_29931.

WRAS\_2010066.

LGA\_29932.

36 627 706

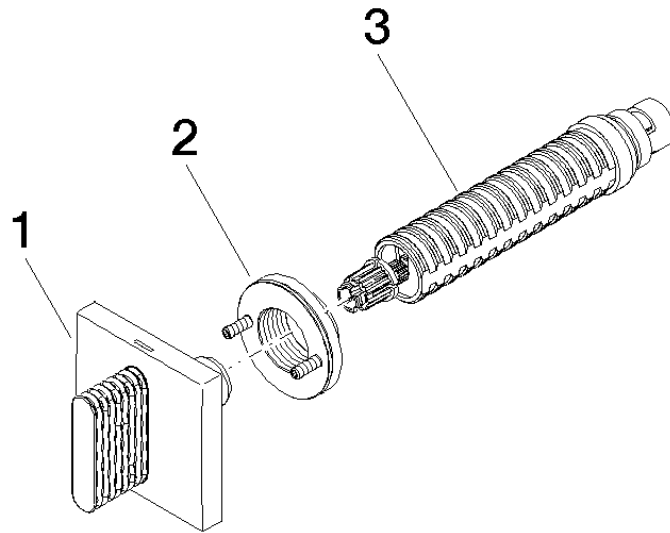

### Spare parts list

No.	Item Number	Name	Quantity used	Delivery time
1	90 20 70 053 02-06	handle ( cold )	1	10
2	90 21 02 108 00 90	disc	1	2
3	90 90 03 143 00 90	top	1	2