

Dispenser wall model - Brushed Platinum













MADISON

83 435 970



- bottle made of crystal glass, matt
- width 60mm
- height 200 mm
- 250 ml bottle
- 96mm projection

Fits: MADISON, MEM, TARA, CL.1, LISSÉ,
VAIA, META, CYO

	Brushed Platinum	83 435 970-06
	Chrome	83 435 970-00
	Platinum	83 435 970-08
	Dark Chrome	83 435 970-19
	Light Gold	83 435 970-26
	Brushed Light Gold	83 435 970-27
	Brushed Durabronze (23kt Gold)	83 435 970-28
	Matte Black	83 435 970-33
	Brushed Bronze	83 435 970-42
	Brushed Champagne (22kt Gold)	83 435 970-46
	Champagne (22kt Gold)	83 435 970-47
	Brushed Chrome	83 435 970-93
	Brushed Dark Platinum	83 435 970-99

83 435 970

mm [inches]

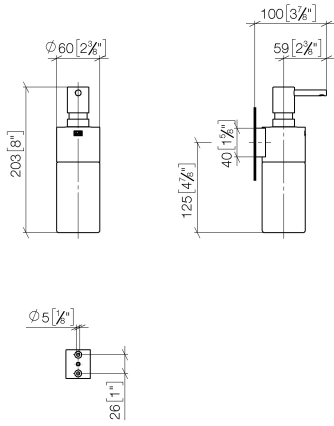

83 435 970

Parts for other finishes can be found here: [Chrome](#)

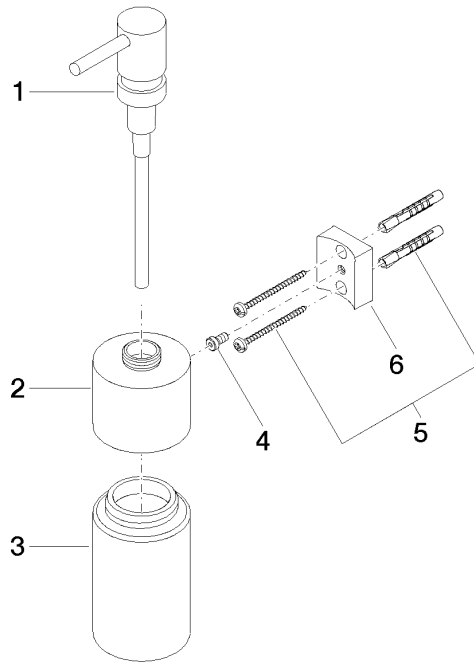

Spare parts list

No.	Item Number	Name	Quantity used	Delivery time
1	90 10 10 535 00-06	dispenser	1	10
2	90 10 10 525 00-06	base	1	10
3	90 90 04 001 00 82	glass	1	2
4	09 30 30 093 90	screw	1	2
5	05 30 31 025 00 90	fixing set	1	2
6	08 10 10 530-06	holder	1	10