







ST 030 100 5811



- 167mm projection
- rectangular, air-enriched flow
- max. flow 23.8 l/min at 3 bar flow pressure
- Hand shower: COMPACT RAIN, max. flow rate 6.8 l/min (at 3 bar)
- complete hand shower set with anti-scale system
- height of mixer 198 mm
- height up to aerator 133 mm
- hole diameter spout 32 mm
- hole diameter valve 32 mm
- rosette for complete hand shower set 60 x 60mm
- handle Ø 60mm
- metal shower hose 1750mm with integrated anti-twist protection
- with hot / cold marking

	Dark Chrome	ST 030 100 5811-19
	Chrome	ST 030 100 5811-00
	Brushed Platinum	ST 030 100 5811-06
	Brushed Durabronze (23kt Gold)	ST 030 100 5811-28
	Brushed Champagne (22kt Gold)	ST 030 100 5811-46
	Champagne (22kt Gold)	ST 030 100 5811-47
	Brushed Dark Platinum	ST 030 100 5811-99

Individual components of this set

You need the following components for this set

1x 27 523 811-19



1x 11 283 811-19





CYO Five-hole bath mixer for bath rim or tile edge installation - Dark Chrome

CYO





ST 030 100 5811

ST 030 100 5811



- 167mm projection
- rectangular, air-enriched flow
- height of mixer 198 mm
- height up to aerator 133 mm
- Hand shower: COMPACT RAIN, max. flow rate 6.8 l/min (at 3 bar)
- complete hand shower set with anti-scale system
- hole diameter spout 32 mm
- hole diameter valve 32 mm
- rosette for complete hand shower set 60 x 60mm
- handle Ø 60mm
- metal shower hose 1750mm with integrated anti-twist protection
- max. flow 23.8 l/min at 3 bar flow pressure

NOTE: The handle inserts must be ordered separately from the fittings!

	Dark Chrome	27 523 811-19
	Chrome	27 523 811-00
	Brushed Platinum	27 523 811-06
	Brushed Durabronze (23kt Gold)	27 523 811-28
	Brushed Dark Platinum	27 523 811-99

ST 030 100 5811

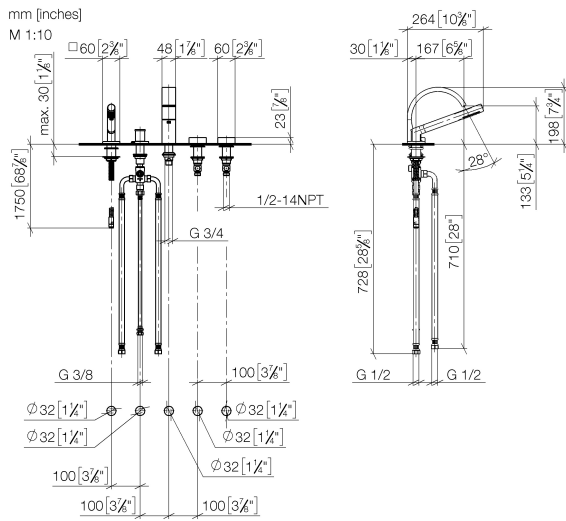

Flow rate chart

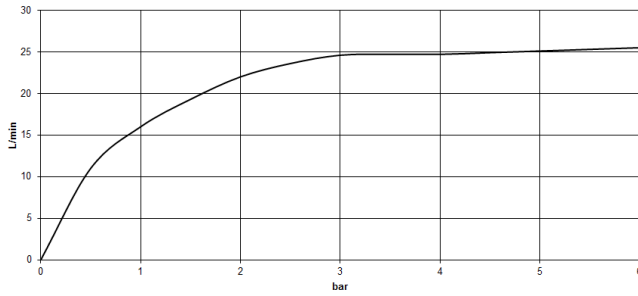

Certificates

WRAS_2204011.

ST 030 100 5811

Parts for other finishes can be found here: [Chrome](#)

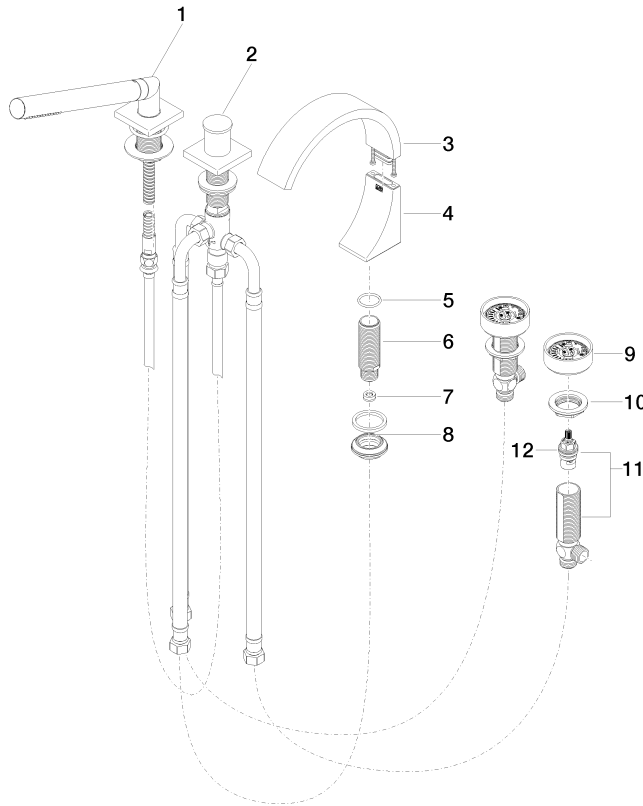

Spare parts list

No.	Item Number	Name	Quantity used	Delivery time
1	27 702 980-19	Hand shower set for bath rim or tile edge installation - Dark Chrome	1	20
2	29 140 670-19	Two-way diverter for bath rim or tile edge installation - Dark Chrome	1	20
3	90 11 70 013 00-19	spout	1	20
4	90 19 70 011 00-19	connection	1	20
5	09 14 10 009 90	seal	1	2
6	09 30 01 117 90	connection	1	2
7	09 23 01 057 90	flow reducer	1	2
8	04 23 10 044 09 90	fixing set	1	2
9	90 18 40 291 01-19	handle	2	20
10	04 30 11 038 68 90	fixing set	1	2
11	04 17 11 055 41 90	side panel	2	2
12	90 90 03 239 00 90	top	2	2

ST 030 100 5811

- with hot / cold marking
- for three-hole basin mixers and five-hole bath mixers

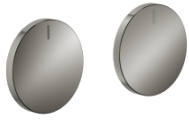

	Dark Chrome	11 283 811-19
	Chrome	11 283 811-00
	Brushed Platinum	11 283 811-06
	Platinum	11 283 811-08
	Durabress (23kt Gold)	11 283 811-09
	Brushed Durabress (23kt Gold)	11 283 811-28
	Brushed Champagne (22kt Gold)	11 283 811-46
	Champagne (22kt Gold)	11 283 811-47
	Brushed Dark Platinum	11 283 811-99



CYO Five-hole bath mixer for bath rim or tile edge installation - Dark Chrome

CYO

ST 030 100 5811



CYO Five-hole bath mixer for bath rim or tile edge installation - Dark Chrome

CYO

ST 030 100 5811



CYO Five-hole bath mixer for bath rim or tile edge installation - Dark Chrome

CYO

ST 030 100 5811

ST 030 100 5811

Parts for other
finishes can be found
here: [Chrome](#)

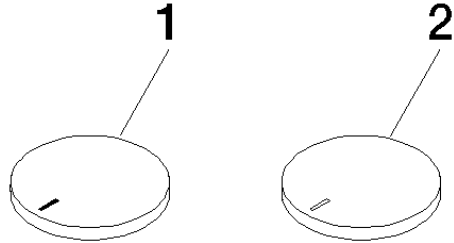



CYO Five-hole bath mixer for bath rim or tile edge installation - Dark Chrome

CYO

ST 030 100 5811