

ST 050 201 8710



- slide bar
- Pipe diameter 18 mm
- Four settings: COMPACT RAIN, COMPACT SOFT FLOW, COMPACT AQUAPRESSURE FLOW, COMPACT CASCADE, max. flow rate 6.8 l/min (at 3 bar)
- rosette 78 x 55 mm
- gauge 800 mm
- metal shower hose 1750mm with integrated anti-twist protection
- shower hose connector 3/8"
- spray head Ø 120mm
- This product can help a building meet the requirements of Green Building Rating Systems, e.g. LEED®, BREEAM®, DGNB

	Chrome	ST 050 201 8710-00 0010
	Chrome	ST 050 201 7710-00
	Brushed Platinum	ST 050 201 7710-06
	Brushed Platinum	ST 050 201 8710-06 0010
	Platinum	ST 050 201 7710-08
	Platinum	ST 050 201 8710-08 0010
	Brushed Durabronze (23kt Gold)	ST 050 201 7710-28
	Brushed Durabronze (23kt Gold)	ST 050 201 8710-28 0010
	Matte Black	ST 050 201 7710-33
	Matte Black	ST 050 201 8710-33 0010
	Brushed Dark Platinum	ST 050 201 7710-99
	Brushed Dark Platinum	ST 050 201 8710-99 0010

Individual components of this set

You need the following components for this set



1x 26 413 710-00



1x 28 012 979-00 0010



LULU Shower set - Chrome

LULU







ST 050 201 8710

ST 050 201 8710



- slide bar
- rosette 78 x 55 mm
- gauge 800 mm
- metal shower hose 1750mm with integrated anti-twist protection
- shower hose connector 3/8"
- Pipe diameter 18 mm
- WRAS 2009048

This article does not include a hand shower!

	Chrome	26 413 710-00
	Brushed Platinum	26 413 710-06
	Platinum	26 413 710-08
	Brushed Durabronze (23kt Gold)	26 413 710-28
	Matte Black	26 413 710-33
	Brushed Dark Platinum	26 413 710-99

Recommended miscellaneous

	Concealed wall elbow - •max. recess depth 163 mm •min. recess depth 90 mm	35 085 970 00
---	--	---------------

Required miscellaneous

	Hand shower - Chrome	28 012 979-00
---	-----------------------------	---------------

Required miscellaneous

	Hand shower - Chrome	28 017 979-00
---	-----------------------------	---------------

Required miscellaneous

	Hand shower - Chrome	28 016 979-00
---	-----------------------------	---------------

Required miscellaneous

	Hand shower FlowReduce - Chrome	28 018 979-00 0010
---	--	-----------------------

Required miscellaneous

	SERIES-VARIOUS Hand shower - Chrome	28 029 979-00 0010
---	--	-----------------------

Required miscellaneous

	SERIES-VARIOUS Hand shower - Chrome	28 025 979-00 0010
---	--	-----------------------

Recommended miscellaneous

	LULU Wall elbow - Chrome	28 450 710-00
---	---------------------------------	---------------

Required miscellaneous

	Hand shower FlowReduce - Chrome	28 016 979-00 0010
---	--	-----------------------

Required miscellaneous

	Hand shower FlowReduce - Chrome	28 012 979-00 0010
---	--	-----------------------

Required miscellaneous

	Hand shower - Chrome	28 018 979-00
---	-----------------------------	---------------

Required miscellaneous

	SERIES-VARIOUS Hand shower - Chrome	28 027 979-00 0010
---	--	-----------------------

Required miscellaneous

	SERIES-VARIOUS Hand shower - Chrome	28 029 979-00
---	--	---------------

ST 050 201 8710

mm [inches]

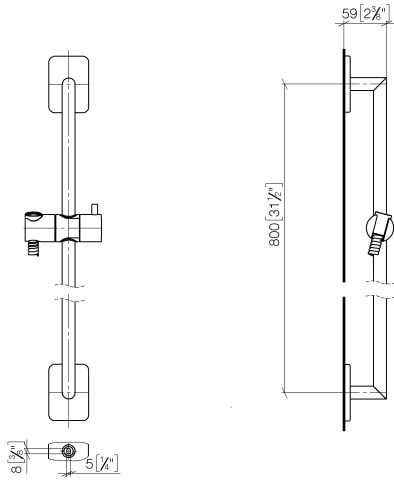

Certificates

WRAS_2009048. ACS_20 ACC LY 738. IAPMO_4976 (2).

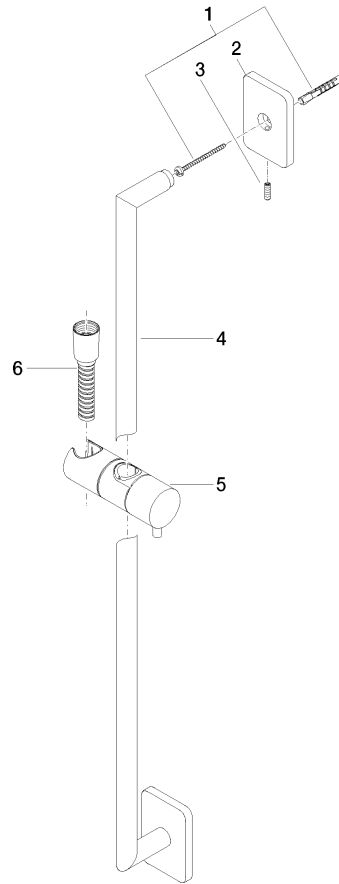

Spare parts list

No.	Item Number	Name	Quantity used	Delivery time
1	05 30 31 025 00 90	fixing set	2	2
2	09 27 71 005-00	rosette	2	10
3	09 31 11 013 90	pin	2	2
4	05 28 22 590 01-00	bar	1	10
5	12 580 970-00	Slide unit - Chrome	1	10
6	28 322 970-00	Metal shower hose 1/2" x 3/8" x 1750 mm - Chrome	1	2



























ST 050 201 8710



- Four settings: COMPACT RAIN, COMPACT SOFT FLOW, COMPACT AQUAPRESSURE FLOW, COMPACT CASCADE, max. flow rate 6.8 l/min (at 3 bar)
- with anti-scale system
- spray head Ø 120mm
- 1/2" connection
- This product can help a building meet the requirements of Green Building Rating Systems, e.g. LEED®, BREEAM®, DGNB

Intrinsic protection against back flow.

Fits: IMO, LULU, MADISON, MEM, TARA, CL.1, LISSÉ, VAIA, META, CYO

	Chrome	28 012 979-00 0010
	Chrome	28 012 979-00
	Brushed Platinum	28 012 979-06
	Brushed Platinum	28 012 979-06 0010
	Platinum	28 012 979-08
	Platinum	28 012 979-08 0010
	Dark Chrome	28 012 979-19
	Dark Chrome	28 012 979-19 0010
	Light Gold	28 012 979-26
	Light Gold	28 012 979-26 0010
	Brushed Light Gold	28 012 979-27
	Brushed Light Gold	28 012 979-27 0010
	Brushed Durabronze (23kt Gold)	28 012 979-28
	Brushed Durabronze (23kt Gold)	28 012 979-28 0010
	Matte Black	28 012 979-33 0010
	Matte Black	28 012 979-33
	Brushed Bronze	28 012 979-42
	Brushed Bronze	28 012 979-42 0010
	Brushed Champagne (22kt Gold)	28 012 979-46
	Brushed Champagne (22kt Gold)	28 012 979-46 0010
	Champagne (22kt Gold)	28 012 979-47
	Champagne (22kt Gold)	28 012 979-47 0010
	Brushed Chrome	28 012 979-93
	Brushed Chrome	28 012 979-93 0010
	Brushed Dark Platinum	28 012 979-99 0010
	Brushed Dark Platinum	28 012 979-99



LULU Shower set - Chrome

LULU

ST 050 201 8710



LULU Shower set - Chrome

LULU

ST 050 201 8710



LULU Shower set - Chrome

LULU

ST 050 201 8710

ST 050 201 8710

mm [inches]

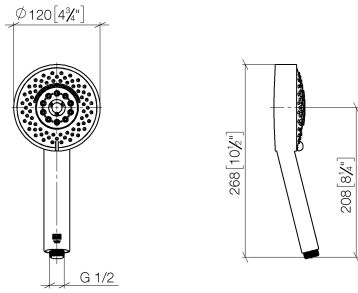

Flow rate chart

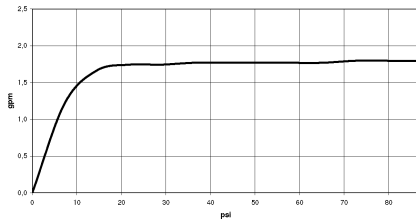

Certificates

LGA_29980.

IAPMO_4976 (4).

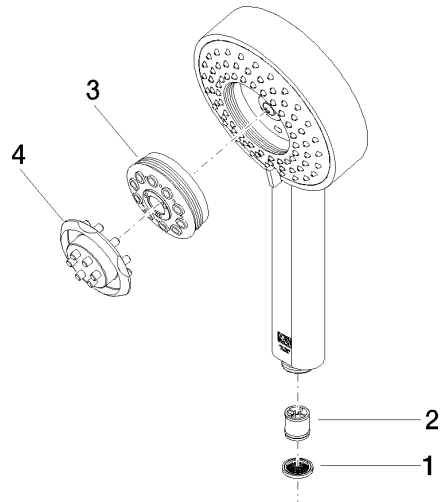

Spare parts list

No.	Item Number	Name	Quantity used	Delivery time
1	09 23 01 039 90	sieve	1	2
2	09 23 01 166 90	flow reducer	1	2
3	04 12 11 071 00 90	shower	1	2
4	09 30 09 022 90	key	1	2