

Concealed single-lever mixer with integrated shower connection with shower set - Chrome

IMO

ST 050 205 9979



- metal shower hose 1750mm with integrated anti-twist protection
 - slide bar
 - Pipe diameter 18 mm
 - Hand shower: COMPACT RAIN, max. flow rate 15 l/min (at 3 bar)
 - spray head Ø 130 mm
- Intrinsic protection against back flow.**

Fits: IMO, LULU, MADISON, MEM, TARA, CL.1, LISSÉ, VAIA, META, CYO

	Chrome	ST 050 205 9979-00
	Brushed Platinum	ST 050 205 9979-06
	Platinum	ST 050 205 9979-08
	Dark Chrome	ST 050 205 9979-19
	Brushed Durabronz (23kt Gold)	ST 050 205 9979-28
	Matte Black	ST 050 205 9979-33
	Brushed Champagne (22kt Gold)	ST 050 205 9979-46
	Champagne (22kt Gold)	ST 050 205 9979-47
	Brushed Chrome	ST 050 205 9979-93
	Brushed Dark Platinum	ST 050 205 9979-99

Individual components of this set

You need the following components for this set



1x 36 110 970-00



1x 28 017 979-00



Concealed single-lever mixer with integrated shower connection with shower set - Chrome

IMO

ST 050 205 9979

Concealed single-lever mixer with integrated shower connection with shower set - Chrome

IMO

ST 050 205 9979



- metal shower hose 1750mm with integrated anti-twist protection
- slide bar
- Pipe diameter 18 mm
- WRAS 2011027

This article does not include a hand shower!

Intrinsic protection against back flow.

This article does not include a hand shower!

Intrinsic protection against back flow.

Fits: IMO, LULU, MADISON, MEM, TARA, CL.1, LISSÉ, VAIA, META, CYO

	Chrome	36 110 970-00
	Brushed Platinum	36 110 970-06
	Platinum	36 110 970-08
	Dark Chrome	36 110 970-19
	Brushed Light Gold	36 110 970-27
	Brushed Durabronze (23kt Gold)	36 110 970-28
	Matte Black	36 110 970-33
	Brushed Bronze	36 110 970-42
	Brushed Champagne (22kt Gold)	36 110 970-46
	Champagne (22kt Gold)	36 110 970-47
	Brushed Chrome	36 110 970-93
	Brushed Dark Platinum	36 110 970-99

Required miscellaneous

	Concealed wall mounting - •max. recess depth 105 mm •min. recess depth 80 mm	35 050 970 00
--	---	---------------

Required miscellaneous

	Hand shower FlowReduce - Chrome	28 016 979-00 0010
--	--	--------------------

Required miscellaneous

	Hand shower FlowReduce - Chrome	28 012 979-00 0010
--	--	--------------------

Required miscellaneous

	Hand shower - Chrome	28 018 979-00
--	-----------------------------	---------------

Required miscellaneous

	SERIES-VARIOUS Hand shower - Chrome	28 027 979-00 0010
--	--	--------------------

Required miscellaneous

	SERIES-VARIOUS Hand shower - Chrome	28 029 979-00
--	--	---------------

Required miscellaneous

	Hand shower - Chrome	28 012 979-00
--	-----------------------------	---------------

Required miscellaneous

	Hand shower - Chrome	28 017 979-00
--	-----------------------------	---------------

Required miscellaneous

	Hand shower - Chrome	28 016 979-00
--	-----------------------------	---------------

Required miscellaneous

	Hand shower FlowReduce - Chrome	28 018 979-00 0010
--	--	--------------------

Required miscellaneous

	SERIES-VARIOUS Hand shower - Chrome	28 029 979-00 0010
--	--	--------------------

Required miscellaneous

	SERIES-VARIOUS Hand shower - Chrome	28 025 979-00 0010
--	--	--------------------

Concealed single-lever mixer with integrated shower connection with shower set - Chrome

IMO

ST 050 205 0070
mm [inches]

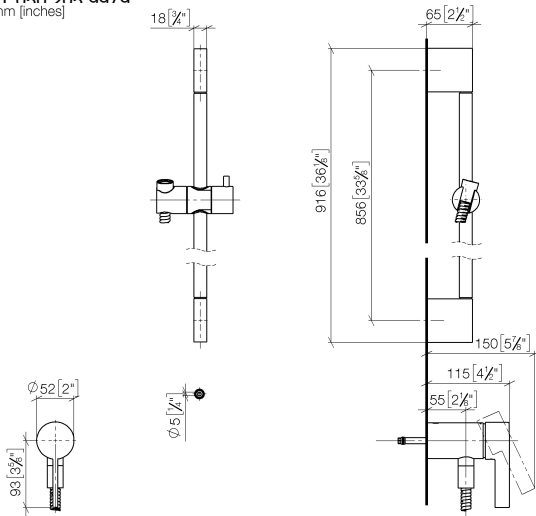

Certificates

Belgaqua_21-025- WRAS_2011027. LGA_29928.
27_1.

ST 050 205 9979

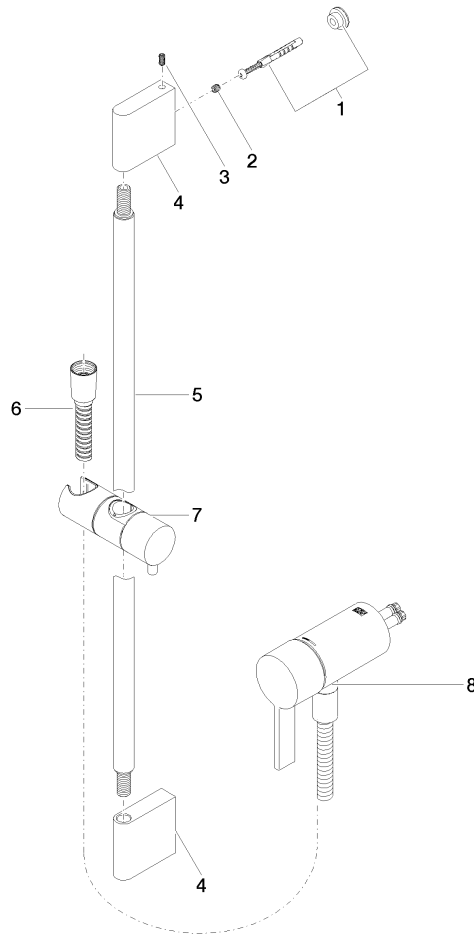

Spare parts list

No.	Item Number	Name	Quantity used	Delivery time
1	05 17 20 726 02 90	fixing set	1	2
2	09 31 11 049 90	pin	2	2
3	04 31 11 113 00 90	pin	2	2
4	08 17 97 054-00	holder	2	10
5	90 28 22 597 00-00	holder	1	10
6	28 322 970-00	Metal shower hose 1/2" x 3/8" x 1750 mm - Chrome	1	2
7	12 580 970-00	Slide unit - Chrome	1	10
9	36 050 970-00	Concealed single-lever mixer with integrated shower connection - Chrome	1	10

Concealed single-lever mixer with integrated shower connection with shower set - Chrome

IMO



























ST 050 205 9979



- COMPACT RAIN, max. flow rate 15 l/min (at 3 bar)
- with anti-scale system
- spray head Ø 130 mm
- 1/2" connection
- WRAS 2009011

Intrinsic protection against back flow.

Fits: IMO, LULU, MADISON, MEM, TARA, CL.1, LISSÉ, VAIA, META, CYO

	Chrome	28 017 979-00
	Chrome	28 017 979-00 0010
	Brushed Platinum	28 017 979-06 0010
	Brushed Platinum	28 017 979-06
	Platinum	28 017 979-08 0010
	Platinum	28 017 979-08
	Dark Chrome	28 017 979-19
	Dark Chrome	28 017 979-19 0010
	Light Gold	28 017 979-26 0010
	Light Gold	28 017 979-26
	Brushed Light Gold	28 017 979-27 0010
	Brushed Light Gold	28 017 979-27
	Brushed Durabronze (23kt Gold)	28 017 979-28
	Brushed Durabronze (23kt Gold)	28 017 979-28 0010
	Matte Black	28 017 979-33
	Matte Black	28 017 979-33 0010
	Brushed Bronze	28 017 979-42 0010
	Brushed Bronze	28 017 979-42
	Brushed Champagne (22kt Gold)	28 017 979-46 0010
	Brushed Champagne (22kt Gold)	28 017 979-46
	Champagne (22kt Gold)	28 017 979-47
	Champagne (22kt Gold)	28 017 979-47 0010
	Brushed Chrome	28 017 979-93
	Brushed Chrome	28 017 979-93 0010
	Brushed Dark Platinum	28 017 979-99
	Brushed Dark Platinum	28 017 979-99 0010



Concealed single-lever mixer with integrated shower connection with shower set - Chrome

IMO

ST 050 205 9979



Concealed single-lever mixer with integrated shower connection with shower set - Chrome

IMO

ST 050 205 9979



Concealed single-lever mixer with integrated shower connection with shower set - Chrome

IMO

ST 050 205 9979

Concealed single-lever mixer with integrated shower connection with shower set - Chrome

ST 050 205 0070
mm [inches]

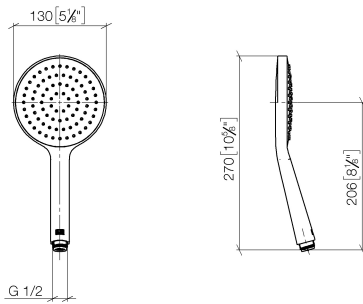

Flow rate chart



Certificates

DVGW_DW-
6517DN0129.

LGA_29983.

WRAS_2009011.

ST 050 205 9979



Spare parts list

No.	Item Number	Name	Quantity used	Delivery time
1	09 23 01 039 90	sieve	1	2