





ST 110 104 1680



- 235mm projection
- pivotable spout 360°
- air-enriched flow and spray flow
- height of mixer 345 mm
- test
- height up to aerator 319 mm
- cover plate 126 x 55 mm
- single-lever mixer hole diameter 44 mm
- hole diameter spout 35 mm
- profi spray hole diameter 30mm
- gauge 71 mm
- automatic spout/shower diverter
- sprayface with anti-scaling system
- max. flow 8 l/min at 3 bar flow pressure
- lead-free
- This product can help a building meet the requirements of Green Building Rating Systems, e.g. LEED®, BREEAM®, DGNB

	Chrome	ST 110 104 1680-00
	Brushed Platinum	ST 110 104 1680-06
	Platinum	ST 110 104 1680-08
	Dark Chrome	ST 110 104 1680-19
	Brushed Dark Platinum	ST 110 104 1680-99

Individual components of this set

You need the following components for this set



1x 32 843 680-00



1x 27 784 970-00



LOT Two-hole mixer with cover plate with profi spray set - Chrome

LOT

ST 110 104 1680

ST 110 104 1680



- 235mm projection
- pivotable spout 360°
- air-enriched flow
- height of mixer 345 mm
- height up to aerator 319 mm
- cover plate 126 x 55 mm
- hole diameter spout 35 mm
- single-lever mixer hole diameter 44 mm
- gauge 71 mm
- max. flow 8 l/min at 3 bar flow pressure
- lead-free
- WRAS 1909073
- This product can help a building meet the requirements of Green Building Rating Systems, e.g. LEED®, BREEAM®, DGNB

	Chrome	32 843 680-00
	Brushed Platinum	32 843 680-06
	Platinum	32 843 680-08
	Dark Chrome	32 843 680-19
	Brushed Durabross (23kt Gold)	32 843 680-28
	Brushed Champagne (22kt Gold)	32 843 680-46
	Champagne (22kt Gold)	32 843 680-47
	Brushed Dark Platinum	32 843 680-99

Recommended miscellaneous

Strainer waste with control handle - Chrome 10 711 970-00



Recommended miscellaneous

Dispenser with rosette - Chrome 82 439 970-00



ST 110 104 1680

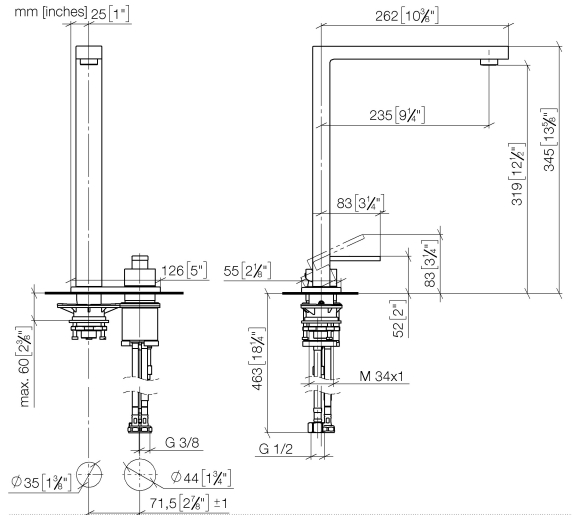

Flow rate chart

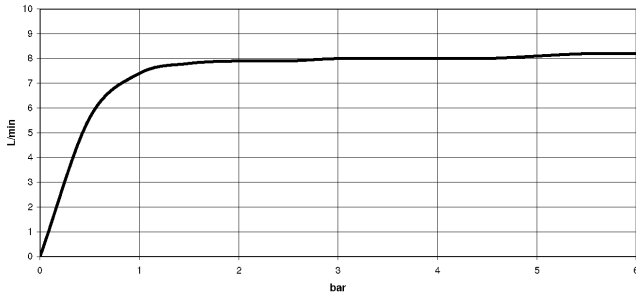

Certificates

GDV_0400283. WRAS_1909073. LGA_18887. ETA_18986.

ST 110 104 1680

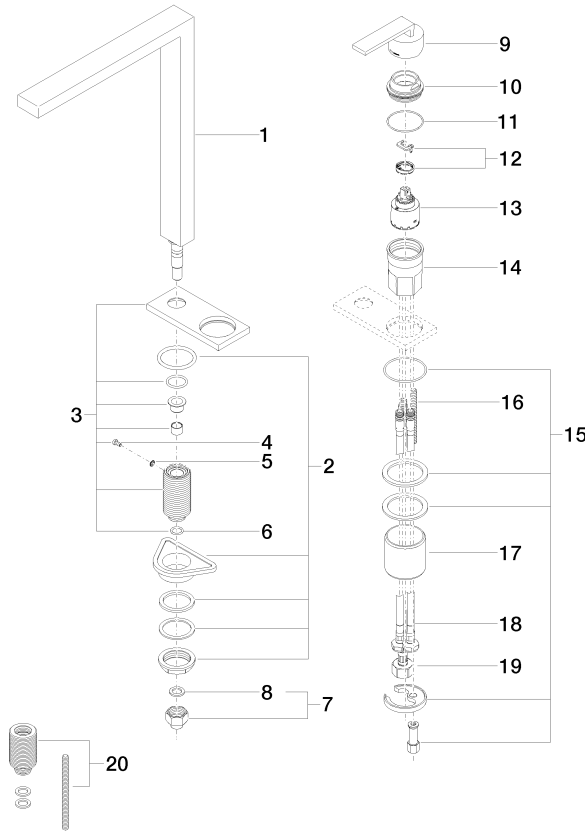

Spare parts list

No.	Item Number	Name	Quantity used	Delivery time
1	90 11 06 188 06-00	spout	1	10
2	04 23 10 044 01 90	fixing set	1	2
3	90 27 78 024 00-00	rosette	1	10
4	09 30 30 057 90	screw	1	2
5	09 30 11 028 90	disc	1	2
6	90 14 10 077 00 90	seal	1	2
7	04 24 04 166 10 90	nipple	1	2
8	90 14 20 002 00 90	seal	1	2
9	90 20 78 040 00-00	handle	1	10
10	09 24 04 142-00	nut	1	10
11	09 14 10 037 90	seal	1	2
12	90 28 10 148 00 90	accessories	1	2
13	90 15 05 061 00 90	cartridge	1	60
14	09 30 01 100 10 90	sleeve	1	2
15	04 30 11 038 02 90	fixing set	1	2
16	09 31 11 011 90	pin	1	2
17	09 18 40 079 90	sleeve	1	2
18	04 30 04 104 00 90	hose	2	2
19	04 30 04 019 00 90	hose	1	2
20	12 802 970 90	Extension set -	1	60





ST 110 104 1680



- spray flow
- automatic diverter for spout/Profi spray set
- height of mixer 665 mm
- individual rosette 55 x 55 mm
- profi spray hole diameter 30mm
- sprayface with anti-scaling system
- lead-free

Can only be combined with 32800680, 32843680.

Intrinsic protection against back flow.

	Chrome	27 784 970-00
	Brushed Platinum	27 784 970-06
	Platinum	27 784 970-08
	Dark Chrome	27 784 970-19
	Brushed Chrome	27 784 970-93
	Brushed Dark Platinum	27 784 970-99



LOT Two-hole mixer with cover plate with profi spray set - Chrome

LOT

ST 110 104 1680

ST 110 104 1680

mm [inches]
M 1:10

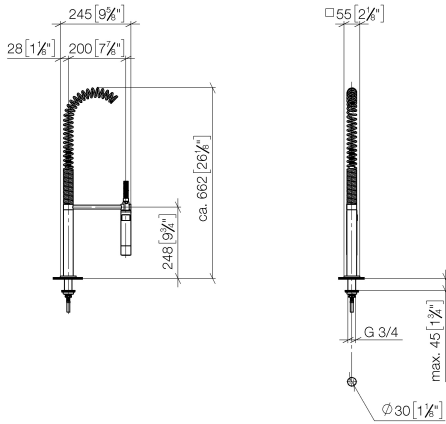

Flow rate chart

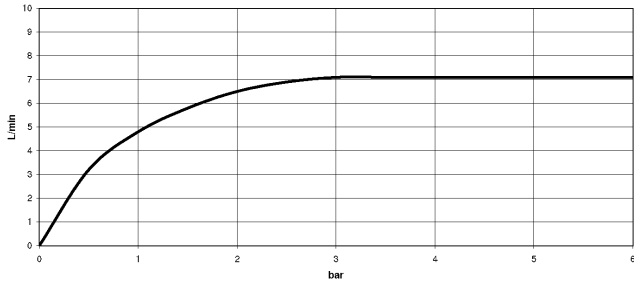

Certificates

Belgaqua_22_277_2
7_3.

ST 110 104 1680

Parts for other finishes can be found here: Brushed Platinum

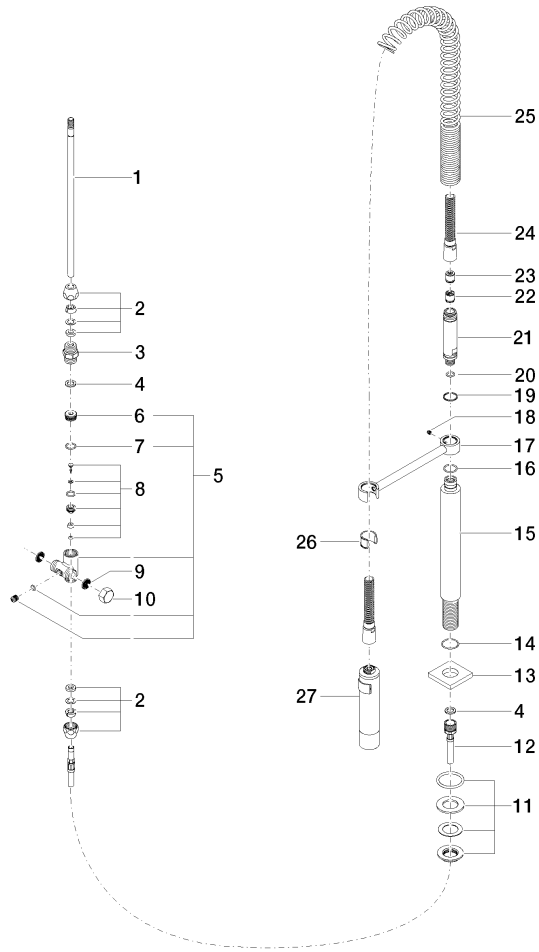

ST 110 104 1680

Spare parts list

No.	Item Number	Name	Quantity used	Delivery time
1	04 24 02 046 01-07	pipe	1	10
2	90 23 30 040 00-00	threaded connector	2	10
3	90 24 03 168 00 90	nipple	1	2
4	90 14 20 002 00 90	seal	2	2
5	90 17 09 046 10 90	diverter	1	2
6	09 24 04 112 10 90	nipple	1	2
7	90 14 10 033 00 90	seal	1	2
8	90 21 10 031 10 90	diverter	1	2
9	09 23 01 039 90	sieve	2	2
10	04 21 02 006 00 92	cap	1	2
11	04 23 10 004 03 90	fixing set	1	2
12	09 30 04 067 90	hose	1	2
13	09 27 97 033-00	rosette	1	10
14	09 14 10 120 90	seal	1	2
15	09 11 10 066 10-00	connection	1	60
16	09 14 10 031 90	seal	1	2
17	04 17 20 014 00-00	holder	1	10
18	09 31 11 049 90	pin	1	2
19	09 14 15 012 90	ring	1	2
20	09 14 10 003 90	seal	1	2
21	09 30 01 067 10-00	adaptor	1	10
22	90 23 01 141 00 90	back-flow preventer	1	2
23	09 23 01 046 90	back-flow preventer	1	2
24	90 30 02 065 00-00	hose	1	10
25	09 16 02 034 90	spring	1	2
26	90 18 40 035 00 90	sleeve	1	2
27	04 12 11 094 10-00	shower	1	10



LOT Two-hole mixer with cover plate with profi spray set - Chrome

LOT

ST 110 104 1680