







## CL.1 Deck valve anti-clockwise closing hot - Brushed Platinum

---

20 000 706 Product version from 3/9/2015

- hole diameter valve 32 mm
- rosette 60 x 60 mm
- with hot marking
- WRAS



|   |                               |               |
|---|-------------------------------|---------------|
|  | Brushed Platinum              | 20 000 706-06 |
|  | Chrome                        | 20 000 706-00 |
|  | Dark Chrome                   | 20 000 706-19 |
|  | Brushed Champagne (22kt Gold) | 20 000 706-46 |
|  | Champagne (22kt Gold)         | 20 000 706-47 |
|  | Brushed Dark Platinum         | 20 000 706-99 |

**CL.1 Deck valve anti-clockwise closing hot - Brushed Platinum**

20 000 706 Product version from 3/9/2015

mm [inches]

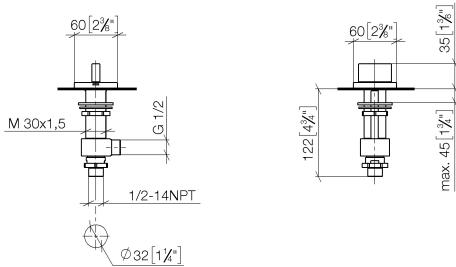

**Flow rate chart**



**Codes & Standards**

ASME A112.18.1      cUPC      DIN 4109      ISO 3822

Scottish Water Byelaws      UK Water Supply Regulations      Ü-Zeichen



## CL.1 Deck valve anti-clockwise closing hot - Brushed Platinum

---

20 000 706 Product version from 3/9/2015

### Certificates

---

IAPMO\_4976

WRAS\_2103

LGA\_28

## CL.1 Deck valve anti-clockwise closing hot - Brushed Platinum

20 000 706 Product version from 3/9/2015

Parts for other finishes can be found here: [Chrome](#)

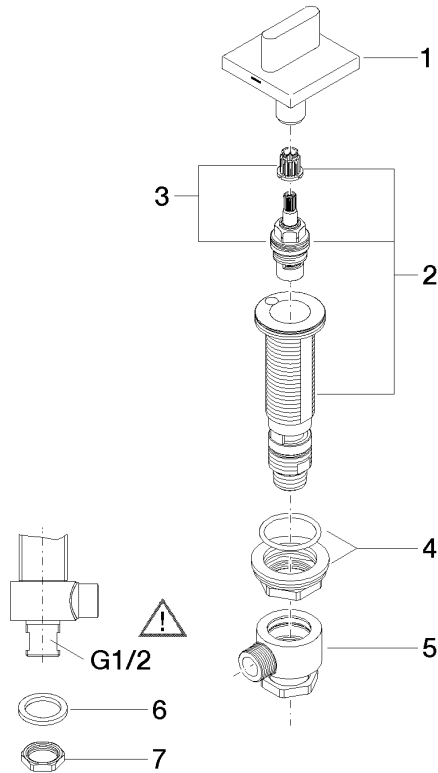

### Spare parts list

| No. | Item Number        | Name               | Quantity used | Delivery time |
|-----|--------------------|--------------------|---------------|---------------|
| 1   | 90 20 70 051 05-06 | handle ( hot )     | 1             | 10            |
| 2   | 04 17 11 058 32 90 | side panel         | 1             | 2             |
| 3   | 90 90 03 132 00 90 | top                | 1             | 2             |
| 4   | 04 23 10 032 78 90 | fixing set         | 1             | 2             |
| 5   | 04 17 11 023 10 90 | distributor        | 1             | 2             |
| 6   | 90 23 30 040 00-06 | threaded connector | 1             | 10            |
| 7   | 09 30 11 059 90    | disc               | 1             | 2             |
| 8   | 09 23 10 012 90    | nut                | 1             | 2             |