







20 713 882



- 165mm projection
- pivotable spout 360°
- circular, air-enriched flow
- height of mixer 285 mm
- height up to aerator 163 mm
- hole diameter valve 32 mm
- hole diameter spout 35 mm
- rosette Ø 55 mm
- 2x screw-in M 10 x 1 pressure hose, leak-tested
- max. flow 7 l/min
- lead-free
- WRAS 2212026
- This product can help a building meet the requirements of Green Building Rating Systems, e.g. LEED®, BREEAM®, DGNB

Only suitable for basins with an overflow.

	Brushed Chrome	20 713 882-93
	Chrome	20 713 882-00
	Brushed Platinum	20 713 882-06
	Platinum	20 713 882-08
	Dark Chrome	20 713 882-19
	Brushed Durabronze (23kt Gold)	20 713 882-28
	Matte Black	20 713 882-33
	Brushed Champagne (22kt Gold)	20 713 882-46
	Champagne (22kt Gold)	20 713 882-47
	Brushed Dark Platinum	20 713 882-99

20 713 882

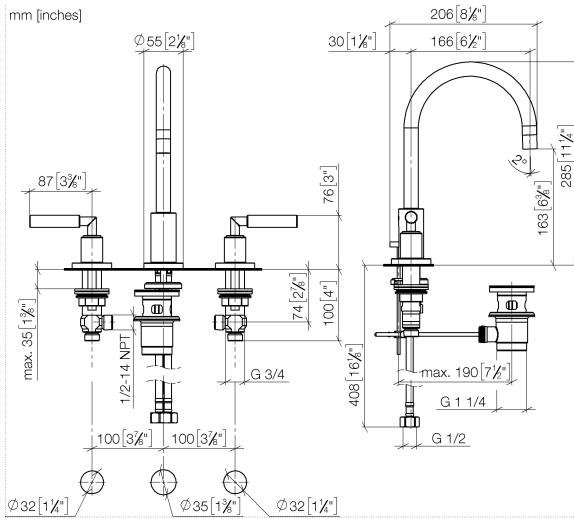

Flow rate chart

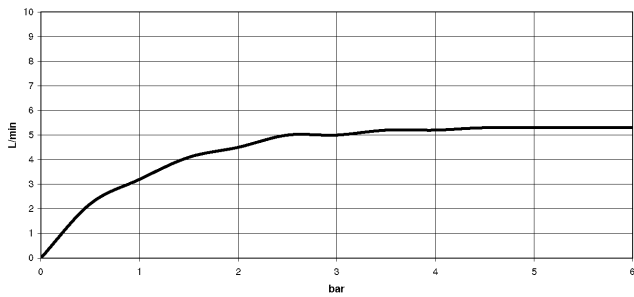

Certificates

LGA_18925.

ETA_18514.

WRAS_2212026.

ACS_20 ACC LY 736. GDV_0400289.

20 713 882

Parts for other finishes can be found here: [Chrome](#)

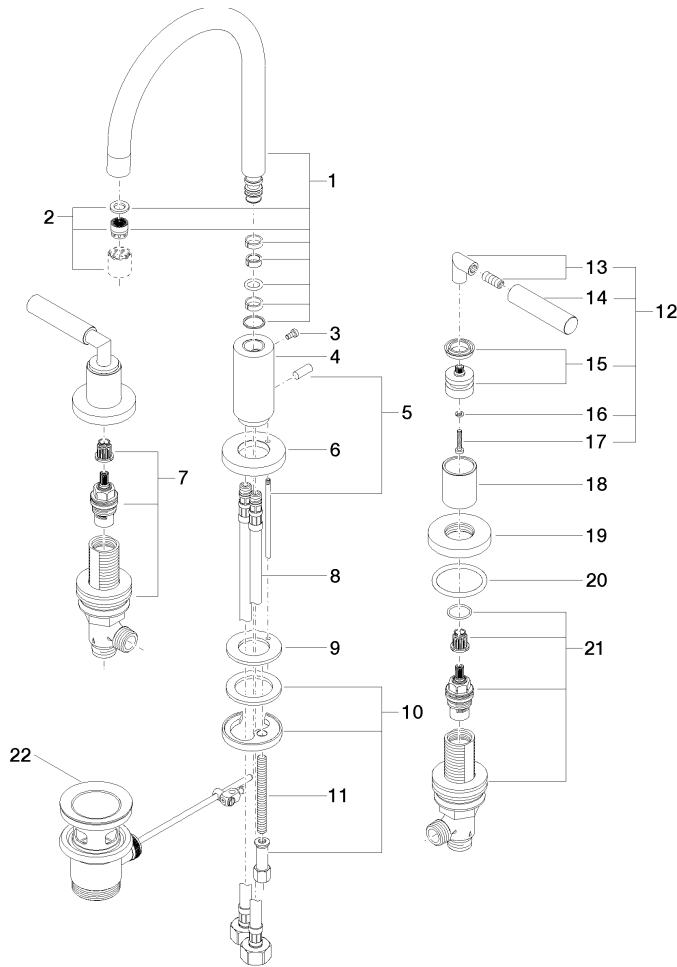



TARA Three-hole basin mixer with pop-up waste - Brushed Chrome

TARA

20 713 882

Spare parts list

No.	Item Number	Name	Quantity used	Delivery time
1	90 28 22 213 01-93	spout	1	20
2	90 23 01 028 03-93	aerator	1	20
3	09 30 30 057 90	screw	1	2
4	09 11 10 087 10-93	connection	1	20
5	04 20 89 030 80-93	pull-rod	1	20
6	09 28 10 133-93	ring	1	20
7	90 17 11 040 51 90	side panel	1	2
8	04 30 04 019 00 90	hose	2	2
9	09 14 05 047 90	seal	1	2
10	04 30 11 038 00 90	fixing set	1	2
11	09 31 11 011 90	pin	1	2
12	04 20 88 052 00-93	handle	2	20
13	04 18 20 022 00-93	angle	2	-
Spare part can no longer be ordered, please order the replacement item				
14	09 20 88 052-93	handle	2	20
15	90 12 12 007 00-93	base	2	20
16	90 30 11 029 00 90	disc	2	2
17	90 30 30 075 00 90	screw	2	2
18	09 21 02 140-93	sleeve	2	20
19	09 27 89 105-93	rosette	2	20
20	90 14 10 043 00 90	seal	2	2
21	90 17 11 040 50 90	side panel	1	2
22	90 11 01 001 00-93	pop-up waste	1	20