

22 513 892



- 165mm projection
- pivotable spout 360°
- circular, air-enriched flow
- height of mixer 295 mm
- height up to aerator 172 mm
- hole diameter 35 mm
- rosette Ø 59 mm
- 2x screw-in M 10 x 1 pressure hose, leak-tested
- max. flow 7 l/min
- lead-free
- This product can help a building meet the requirements of Green Building Rating Systems, e.g. LEED®, BREEAM®, DGNB
- WRAS 1810003

Only suitable for basins with an overflow.

	Chrome	22 513 892-00
	Brushed Platinum	22 513 892-06
	Platinum	22 513 892-08
	Dark Chrome	22 513 892-19
	Brushed Durabronze (23kt Gold)	22 513 892-28
	Matte Black	22 513 892-33
	Brushed Bronze	22 513 892-42
	Brushed Champagne (22kt Gold)	22 513 892-46
	Champagne (22kt Gold)	22 513 892-47
	Brushed Chrome	22 513 892-93
	Brushed Dark Platinum	22 513 892-99

22 513 892

mm [inches]

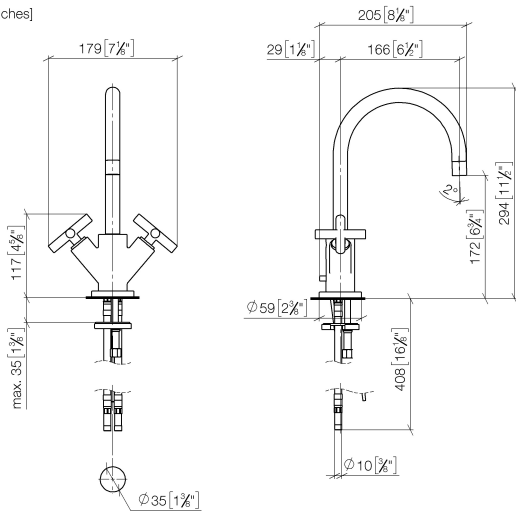

Flow rate chart



Codes & Standards

DIN 4109

EN 200

Executive Order
no. 1007

ISO 3822

Scottish Water
Byelaws

UK Water Supply
Regulations

Ü-Zeichen

VA-Zeichen



TARA Single-hole basin mixer with pop-up waste - Chrome

TARA

22 513 892

Certificates

LGA_18

GDV_0400

ETA_18

WRAS_1810

22 513 892

Product version from 6/30/2009 to 5/27/2021

Product version from 5/27/2021

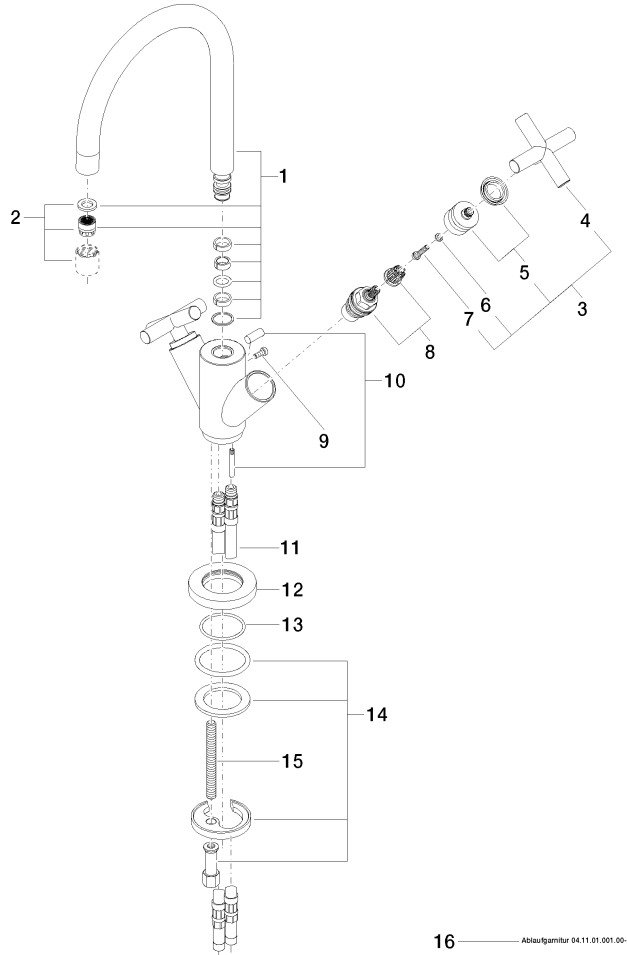



TARA Single-hole basin mixer with pop-up waste - Chrome

TARA

22 513 892

Spare parts list

Product version from 6/30/2009 to 5/27/2021

Product version from 5/27/2021

No.	Item Number	Name	Quantity used	Delivery time
	90 28 22 213 01-00	spout	23	10