

**TARA Two-hole bath mixer for free-standing assembly with hand shower set -
Brushed Chrome**







TARA

25 943 892



- 220mm projection
- pivotable spout 180°
- Hand shower: COMPACT RAIN, max. flow rate 6.8 l/min (at 3 bar)
- spout: circular, air-enriched flow
- hand shower with anti-scale system
- rotary diverter for bath/shower
- total height 920 mm
- stand pipes height 628 mm
- height up to aerator 765 mm
- slide-on rosettes Ø 90 mm
- gauge 150 mm
- metal shower hose 1250mm with integrated anti-twist protection
- pivotable shower holder on the right foot
- max. flow 22 l/min at 3 bar flow pressure
- WRAS 2212005

Intrinsic protection against back flow.

	Brushed Chrome	25 943 892-93
	Chrome	25 943 892-00
	Brushed Platinum	25 943 892-06
	Platinum	25 943 892-08
	Dark Chrome	25 943 892-19
	Brushed Durabronze (23kt Gold)	25 943 892-28
	Matte Black	25 943 892-33
	Brushed Champagne (22kt Gold)	25 943 892-46
	Champagne (22kt Gold)	25 943 892-47
	Brushed Dark Platinum	25 943 892-99

**TARA Two-hole bath mixer for free-standing assembly with hand shower set -
Brushed Chrome**

TARA

25 943 892
mm [inches]



Flow rate chart



Certificates

WRAS_2212005. LGA_18932. IAPMO_4976 (2). Belgaqua_21-033-
27_2.

TARA Two-hole bath mixer for free-standing assembly with hand shower set -
Brushed Chrome

TARA

25 943 892

Parts for other
finishes can be found
here: [Chrome](#)

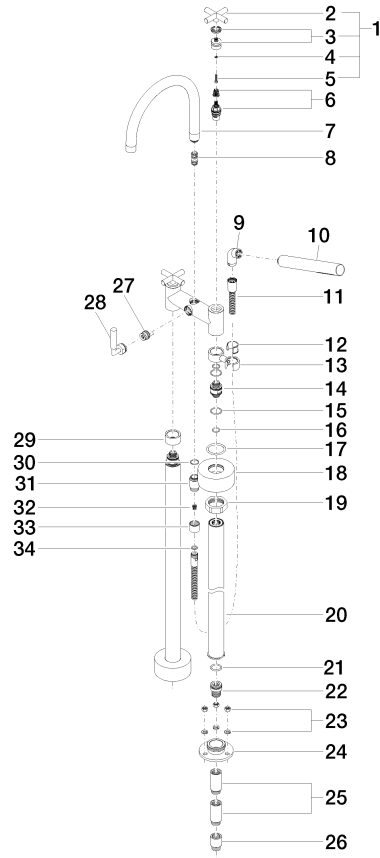



TARA Two-hole bath mixer for free-standing assembly with hand shower set - Brushed Chrome

TARA

25 943 892

Spare parts list

No.	Item Number	Name	Quantity used	Delivery time
1	90 20 89 010 10-93	handle	2	20
2	09 20 89 010-93	handle	2	60
3	90 12 12 007 00-93	base	2	20
4	90 30 11 029 00 90	disc	2	2
5	90 30 30 075 00 90	screw	2	2
6	90 90 03 131 00 90	top	2	2
7	90 28 22 222 00-93	spout	1	20
8	90 21 10 011 00 90	diverter	1	2
9	04 24 04 189 00-93	nipple	1	20
10	90 12 11 140 30-93	shower	1	20
11	90 30 02 072 00-93	Metal shower hose 1/2" x 3/8" x 1250 mm - Brushed Chrome	1	20
12	90 18 40 035 00 90	sleeve	1	2
13	04 28 10 029 01-93	holder	1	20
14	09 29 05 021 20 90	nipple	2	2
15	09 14 10 112 90	seal	4	2
16	90 14 10 055 00 90	seal	4	2
17	09 14 10 041 90	seal	2	2
18	09 27 89 025-93	rosette	2	20
19	09 23 30 040-07	nut	2	30
20	04 28 22 009 20-93	connection	2	20
21	09 14 10 081 90	seal	2	2
22	09 24 03 094-07	nipple	2	30
23	04 23 10 023 00 90	fixing set	6	2
24	09 30 11 130-07	connection	2	30
25	09 24 03 081 10 90	extension	4	2
26	09 24 03 080 90	extension	2	2
27	90 15 01 005 00 90	insert	1	2
28	90 18 20 025 00-93	diverter	1	20
29	09 28 10 028-93	sleeve	1	20
30	90 14 10 032 00 90	seal	1	2
31	09 24 03 121-93	nipple	1	20
32	09 23 01 131 90	back-flow preventer	1	2
33	09 21 02 143-93	sleeve	1	20
34	90 14 20 026 00 90	seal	1	2