





CYO Five-hole bath mixer for bath rim or tile edge installation - Brushed Durabronz (23kt Gold)

27 523 811 Product version from 7/1/2023



- 167mm projection
- rectangular, air-enriched flow
- height of mixer 198 mm
- height up to aerator 133 mm
- Hand shower: COMPACT RAIN, max. flow rate 6.8 l/min (at 3 bar)
- complete hand shower set with anti-scale system
- hole diameter spout 32 mm
- hole diameter valve 32 mm
- rosette for complete hand shower set 60 x 60mm
- handle Ø 60mm
- metal shower hose 1750mm with integrated anti-twist protection
- max. flow 23.8 l/min at 3 bar flow pressure
- WRAS

NOTE: The handle inserts must be ordered separately from the fittings!

	Brushed Durabronz (23kt Gold)	27 523 811-28
	Chrome	27 523 811-00
	Brushed Platinum	27 523 811-06
	Dark Chrome	27 523 811-19
	Brushed Dark Platinum	27 523 811-99



CYO Five-hole bath mixer for bath rim or tile edge installation - Brushed Durabronz (23kt Gold)

27 523 811 Product version from 7/1/2023

mm [inches]

M 1:10

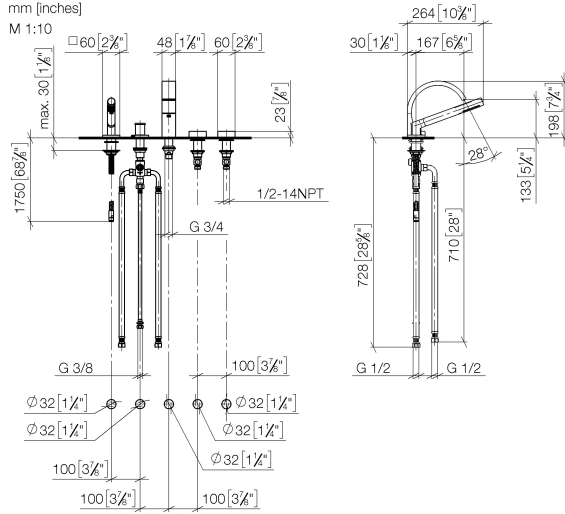

Flow rate chart

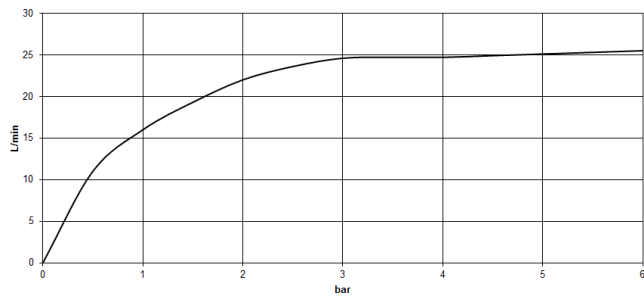

Codes & Standards

DIN 4109

EN 1717

ISO 3822

Scottish Water
Byelaws

UK Water Supply
Regulations

Ü-Zeichen



CYO Five-hole bath mixer for bath rim or tile edge installation - Brushed Durabronss (23kt Gold)

27 523 811 Product version from 7/1/2023

Certificates

WRAS_2204

LGA_38

Belgaqua_21-380-2

CYO Five-hole bath mixer for bath rim or tile edge installation - Brushed Durabron (23kt Gold)

27 523 811 Product version from 7/1/2023

Parts for other finishes can be found here: [Chrome](#)

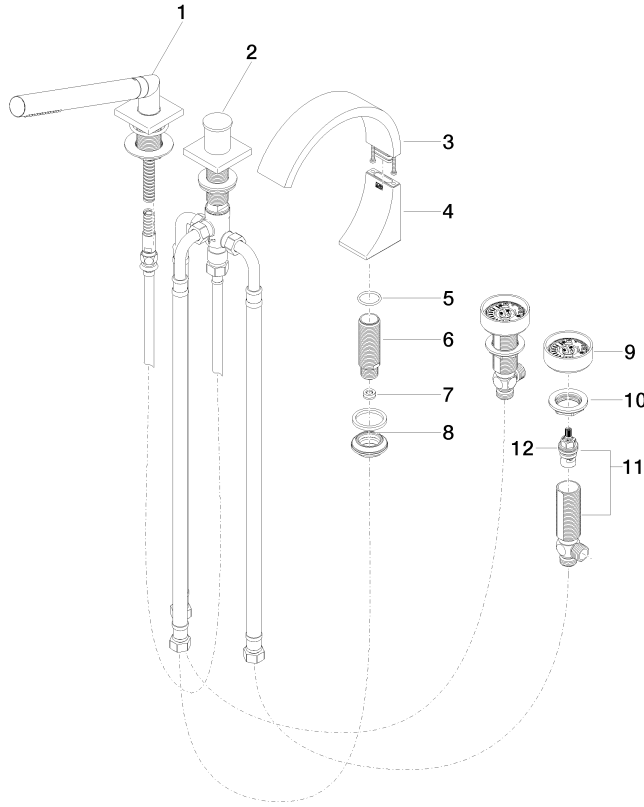

Spare parts list

No.	Item Number	Name	Quantity used	Delivery time
1	27 702 980-28	Hand shower set for bath rim or tile edge installation - Brushed Durabron (23kt Gold)	1	20
2	29 140 670-28	Two-way diverter for bath rim or tile edge installation - Brushed Durabron (23kt Gold)	1	20
3	90 11 70 013 00-28	spout	1	20
4	90 19 70 011 00-28	connection	1	20
5	09 14 10 009 90	seal	1	2
6	09 30 01 117 90	connection	1	2
7	09 23 01 057 90	flow reducer	1	2
8	04 23 10 044 09 90	fixing set	1	2
9	90 18 40 291 01-28	handle	2	20
10	04 30 11 038 68 90	fixing set	1	2
11	04 17 11 055 41 90	side panel	2	2
12	90 90 03 239 00 90	top	2	2