















## Wall elbow - Platinum

28 450 980 Product version from 3/2/2021



- 3/8" shower outlet
- rosette 60 x 60 mm
- 1/2" connection
- WRAS

Intrinsic protection against back flow.

	Platinum	28 450 980-08
	Chrome	28 450 980-00
	Brushed Platinum	28 450 980-06
	Durabronze (23kt Gold)	28 450 980-09
	Dark Chrome	28 450 980-19
	Light Gold	28 450 980-26
	Brushed Light Gold	28 450 980-27
	Brushed Durabronze (23kt Gold)	28 450 980-28
	Matte Black	28 450 980-33
	Brushed Bronze	28 450 980-42
	Brushed Champagne (22kt Gold)	28 450 980-46
	Champagne (22kt Gold)	28 450 980-47
	Brushed Chrome	28 450 980-93
	Brushed Dark Platinum	28 450 980-99

## Recommended miscellaneous

- Concealed wall elbow -**
- max. recess depth mm
  - min. recess depth mm

35 085 970 90



## Wall elbow - Platinum

28 450 980 Product version from 3/2/2021

mm [inches]

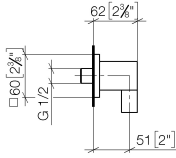

### Flow rate chart

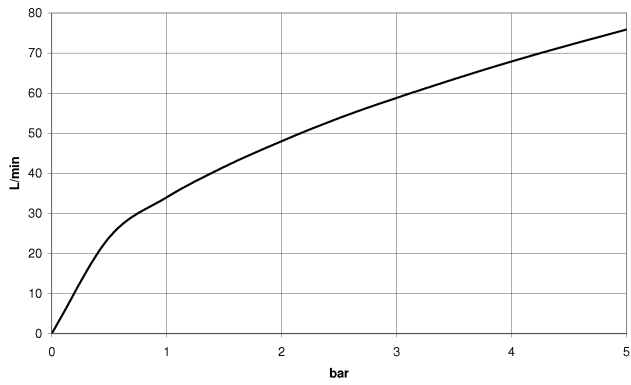

### Codes & Standards

ASME A112.18.1

cUPC

EN 1717

Scottish Water  
Byelaws

UK Water Supply  
Regulations



## Wall elbow - Platinum

---

28 450 980 Product version from 3/2/2021

### Certificates

---

Belgaqua\_22\_280\_2 WRAS\_2310

WRAS\_1807

IAPMO\_4976

## Wall elbow - Platinum

28 450 980 Product version from 3/2/2021

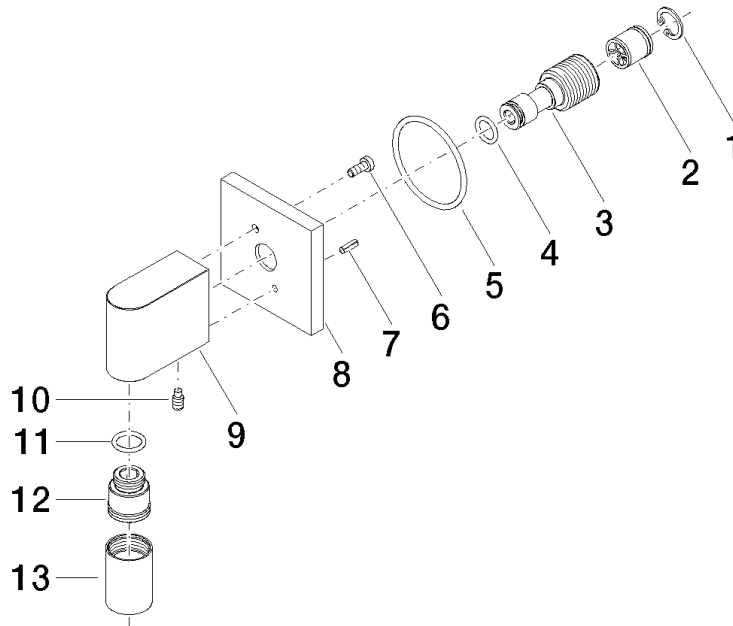

### Spare parts list

No.	Item Number	Name	Quantity used	Delivery time
1	09 16 01 014 90	ring	1	2
2	90 23 01 141 00 90	back-flow preventer	1	2
3	09 24 03 116 20 90	nipple	1	2
4	09 14 10 008 90	seal	1	2
5	09 14 10 142 90	seal	1	2
6	09 30 30 054 90	screw	1	2
7	09 31 11 026 90	pin	1	2
8	09 27 82 006-08	rosette	1	40
9	09 11 03 046-08	connection	1	40
10	09 31 11 005 90	pin	1	2
11	90 14 10 077 00 90	seal	1	2
12	09 24 03 107 20 90	nipple	1	2
13	90 21 02 069 00-08	cover	1	40