







Rain shower with wall fixing FlowReduce 400 mm - Brushed Platinum

28 658 970 Product version from 4/1/2024



- 450mm projection
- rain shower Ø 400 mm
- PURE RAIN, max. flow rate 12 l/min (at 3 bar)
- Function from: 12 l/min
- rosette Ø 60 mm
- 1/2" connection
- with anti-scale system
- This product can help a building meet the requirements of Green Building Rating Systems, e.g. LEED®, BREEAM®, DGNB

To be provided by the customer. Zigbee Gateway!

| | | |
|---|-------------------------------------|---------------|
|  | Brushed Platinum | 28 658 970-06 |
|  | Chrome | 28 658 970-00 |
|  | Platinum | 28 658 970-08 |
|  | Dark Chrome | 28 658 970-19 |
|  | Light Gold | 28 658 970-26 |
|  | Brushed Light Gold | 28 658 970-27 |
|  | Brushed Durabrass (23kt Gold) | 28 658 970-28 |
|  | Matte Black | 28 658 970-33 |
|  | Brushed Bronze | 28 658 970-42 |
|  | Brushed Champagne (22kt Gold) | 28 658 970-46 |
|  | Champagne (22kt Gold) | 28 658 970-47 |
|  | Brushed Chrome | 28 658 970-93 |
|  | Brushed Dark Platinum | 28 658 970-99 |

Rain shower with wall fixing FlowReduce 400 mm - Brushed Platinum

28 658 970 Product version from 4/1/2024

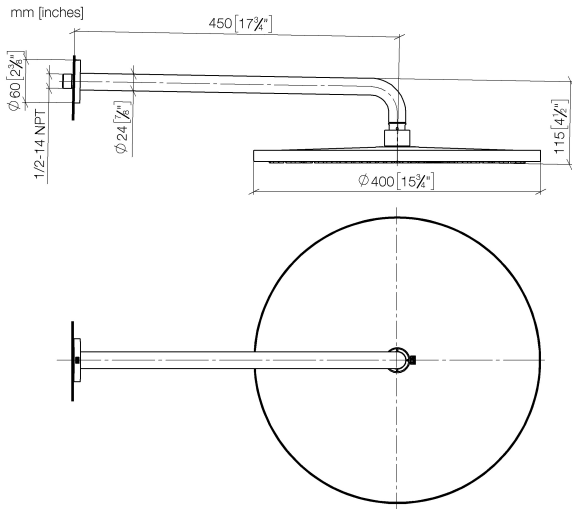

Flow rate chart

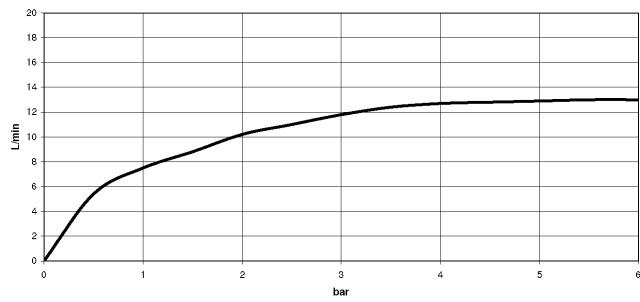

Codes & Standards

DIN 4109

ISO 3822

Ü-Zeichen



Rain shower with wall fixing FlowReduce 400 mm - Brushed Platinum

28 658 970 Product version from 4/1/2024

Certificates

LGA_38

Rain shower with wall fixing FlowReduce 400 mm - Brushed Platinum

28 658 970 Product version from 4/1/2024

Parts for other finishes can be found here: [Chrome](#)

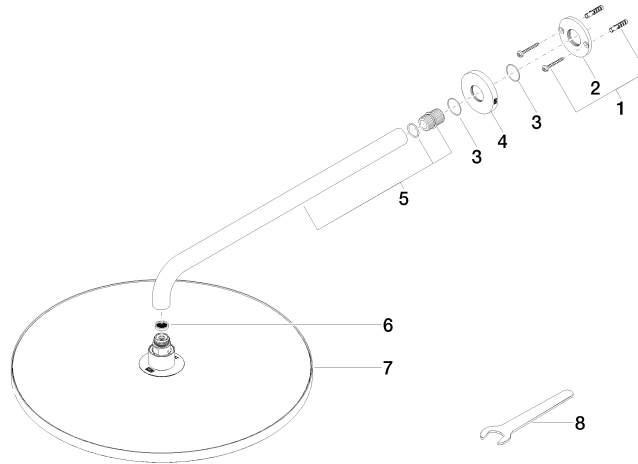

Spare parts list

| No. | Item Number | Name | Quantity used | Delivery time |
|-----|--------------------|------------|---------------|---------------|
| 1 | 04 30 31 032 00 90 | fixing set | 1 | 2 |
| 2 | 09 17 20 120 90 | holder | 1 | 2 |
| 3 | 09 14 10 150 90 | seal | 2 | 2 |
| 4 | 09 27 97 015-06 | rosette | 1 | 10 |
| 5 | 90 11 03 070 00-06 | pipe | 1 | 10 |
| 6 | 09 23 01 075 90 | insert | 1 | 2 |
| 7 | 90 12 05 090 20-06 | shower | 1 | 10 |
| 8 | 90 30 09 069 00 90 | key | 1 | 2 |