













Rain shower with wall fixing FlowReduce 400 mm - Brushed Chrome

28 658 970 Product version from 4/1/2024



- 450mm projection
- rain shower Ø 400 mm
- PURE RAIN, max. flow rate 12 l/min (at 3 bar)
- Function from: 12 l/min
- rosette Ø 60 mm
- 1/2" connection
- with anti-scale system
- This product can help a building meet the requirements of Green Building Rating Systems, e.g. LEED®, BREEAM®, DGNB

To be provided by the customer. Zigbee Gateway!

	Brushed Chrome	28 658 970-93
	Chrome	28 658 970-00
	Brushed Platinum	28 658 970-06
	Platinum	28 658 970-08
	Dark Chrome	28 658 970-19
	Light Gold	28 658 970-26
	Brushed Light Gold	28 658 970-27
	Brushed Durabronze (23kt Gold)	28 658 970-28
	Matte Black	28 658 970-33
	Brushed Bronze	28 658 970-42
	Brushed Champagne (22kt Gold)	28 658 970-46
	Champagne (22kt Gold)	28 658 970-47
	Brushed Dark Platinum	28 658 970-99

Rain shower with wall fixing FlowReduce 400 mm - Brushed Chrome

28 658 970 Product version from 4/1/2024

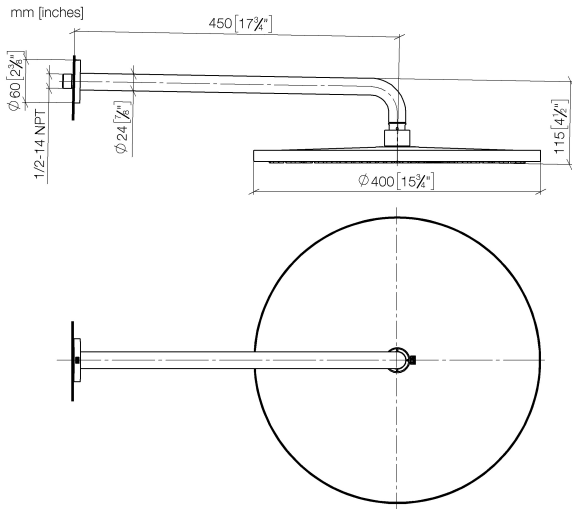

Flow rate chart

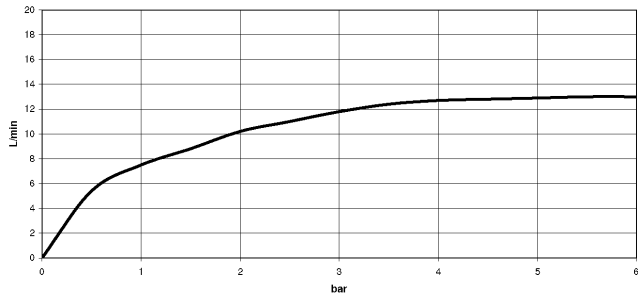

Codes & Standards

DIN 4109

ISO 3822

Ü-Zeichen



Rain shower with wall fixing FlowReduce 400 mm - Brushed Chrome

28 658 970 Product version from 4/1/2024

Certificates

LGA_38

Rain shower with wall fixing FlowReduce 400 mm - Brushed Chrome

28 658 970 Product version from 4/1/2024

Parts for other finishes can be found here: [Chrome](#)

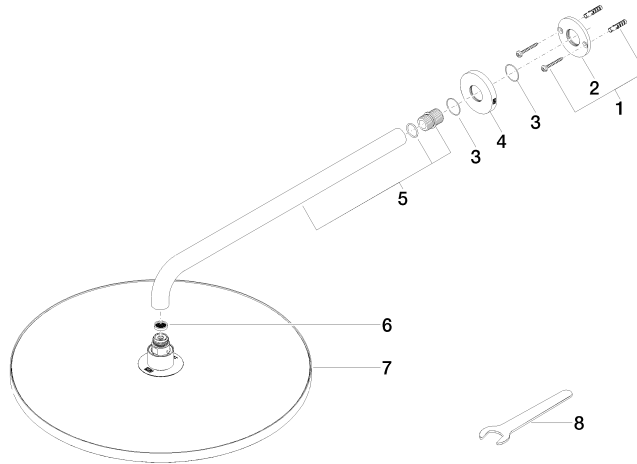

Spare parts list

No.	Item Number	Name	Quantity used	Delivery time
1	04 30 31 032 00 90	fixing set	1	2
2	09 17 20 120 90	holder	1	2
3	09 14 10 150 90	seal	2	2
4	09 27 97 015-93	rosette	1	20
5	90 11 03 070 00-93	pipe	1	20
6	09 23 01 075 90	insert	1	2
7	90 12 05 090 20-93	shower	1	20
8	90 30 09 069 00 90	key	1	2