







33 500 670



- 130mm projection
- fixed spout
- rectangular, air-enriched flow
- height of mixer 154 mm
- height up to aerator 80 mm
- hole diameter 35 mm
- 2x screw-in M 10 x 1 pressure hose, leak-tested
- max. flow 7 l/min
- lead-free
- This product can help a building meet the requirements of Green Building Rating Systems, e.g. LEED®, BREEAM®, DGNB
- WRAS 240202005

Only suitable for basins with an overflow.

	Brushed Platinum	33 500 670-06
	Chrome	33 500 670-00
	Platinum	33 500 670-08
	Brushed Durabronze (23kt Gold)	33 500 670-28
	Brushed Chrome	33 500 670-93
	Brushed Dark Platinum	33 500 670-99

33 500 670

mm [inches]

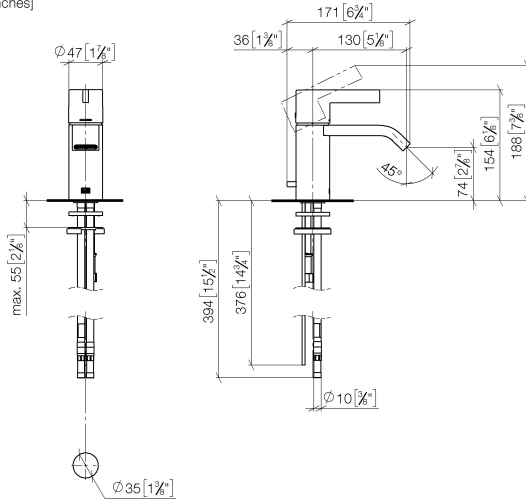

Flow rate chart

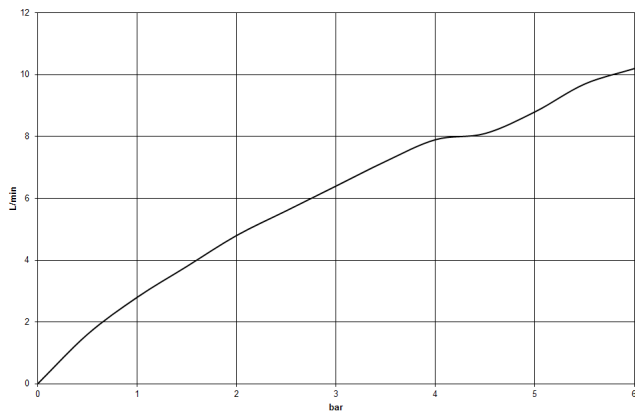

Codes & Standards

DIN 4109

EN 817

Executive Order
no. 1007

ISO 3822

Scottish Water
Byelaws

UK Water Supply
Regulations

Ü-Zeichen

VA-Zeichen



IMO Single-lever basin mixer with pop-up waste - Brushed Platinum

IMO

33 500 670

Certificates

GDV_0400

LGA_19

WRAS_240202

WRAS_1806

ETA_19

33 500 670

Product version up to 10/10/2018

Product version from 10/10/2018 to 5/10/2021

Product version from 5/10/2021

Parts for other finishes can be found here: [Chrome](#)

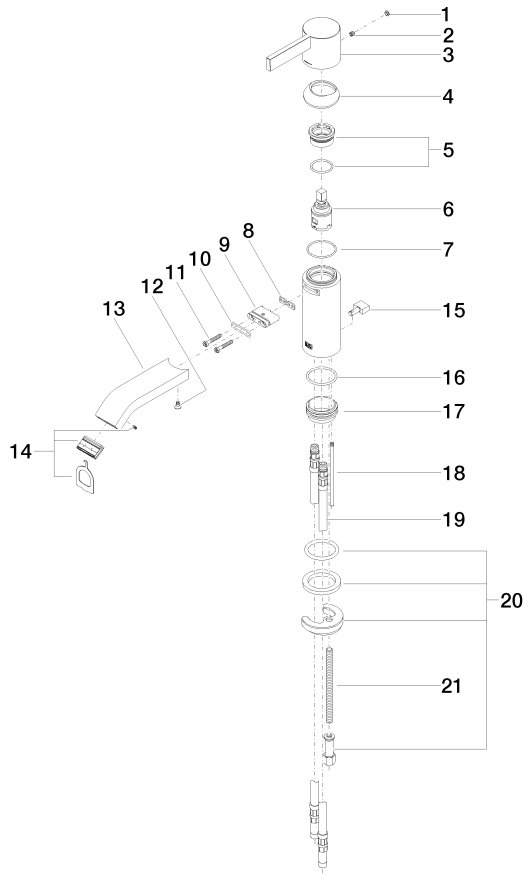

22 ———— Abzugspartikel 04.11.2021.09.4



IMO Single-lever basin mixer with pop-up waste - Brushed Platinum

IMO

33 500 670

Spare parts list

Product version up to 10/10/2018

Product version from 10/10/2018 to 5/10/2021

Product version from 5/10/2021

No.	Item Number	Name	Quantity used	Delivery time
	90 31 20 087 00-06	plug	24	10